

Group 1

Entry system for cables with and without connectors

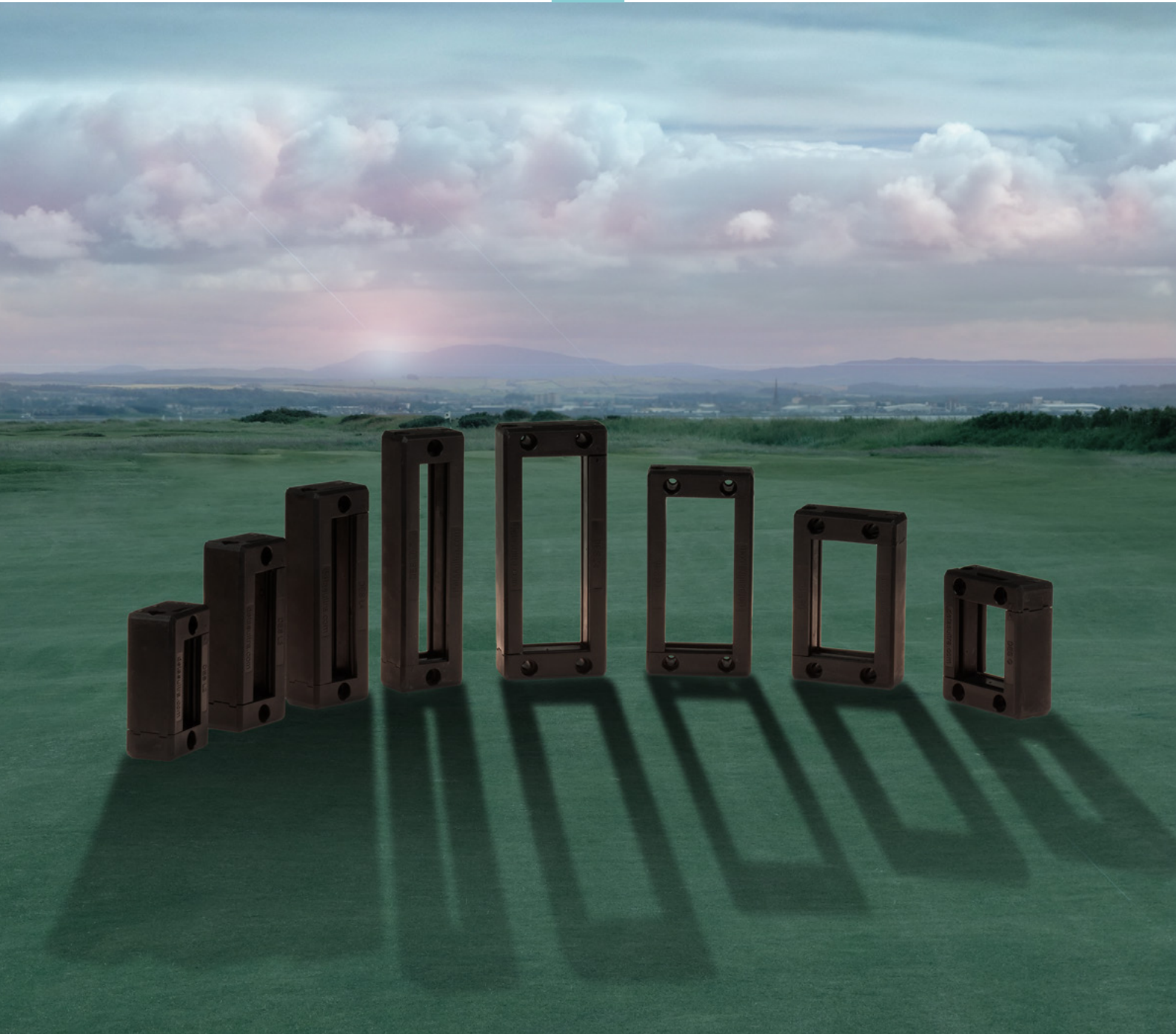



Splittable frame for cables with and without connectors

- ▶ Multiple configurations in the same frame
- ▶ Frame screws in AISI304 Stainless Steel
- ▶ IP66 and NEMA 4X* certified with all configurations of grommets
- ▶ Strain relief according to EN 62444
- ▶ Sturdy construction IK10
- ▶ Overmolded gasket acc. to UL94-V0
- ▶ ATEX version on request (see group 7)
- ▶ Threaded inserts version on request

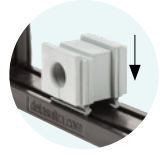
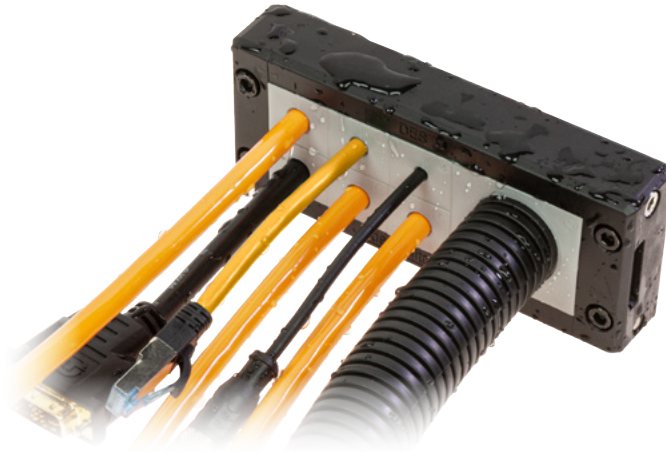

Model	Code	Some possible configurations	Max. cut-out [mm]	Pcs /pack
DES 24	1731010024		112 x 39	10

The DES 24 cable entry system consists of a splittable frame designed to accommodate small (SPP), multiple (X) or large (SPG) grommets for cables with and without connectors. The grommets can be freely positioned into the frame.

With all combinations of grommets, single, double, quadruple, big, the IP66 and NEMA 4X* are guaranteed.

The overmolded gasket guarantees faster installation times and the complete V0 self-extinguishing of the system.

Technical data

Material: PP+GF

Flammability: self-extinguishing acc. to UL94-V0

Temperature: -40°C... +155°C (static)

Features: halogens and silicones free

Upon request:	1731991020	Set of 4 mounting screws in AISI304 with Black Dacromet finishing
---------------	------------	---

Dimensions [mm]

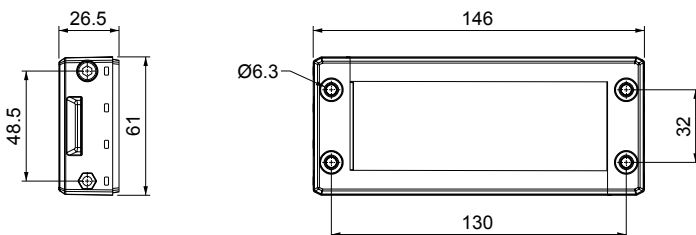

* Indoor only

Related products

SPP grommets (from page 43)

SPG grommets (from page 49)

DES Cover (page 24)

DES Flap (page 25)

HY360 hydraulic punch driver (page 129)

PF/PFX cable entry system plates (from page 130)

DES caps (page 58)

Intumescent gasket (page 117)



IP66

NEMA 12, 4X*

UL TYPE 12, 4X



ECOLAB

UL94-V0



RoHS COMPLIANT

IK10





DES 16



Splittable frame for cables with and without connectors

- ▶ Multiple configurations in the same frame
- ▶ Frame screws in AISI304 Stainless Steel
- ▶ IP66 and NEMA 4X* certified with all configurations of grommets
- ▶ Strain relief according to EN 62444
- ▶ Sturdy construction IK10
- ▶ Overmolded gasket acc. to UL94-V0
- ▶ ATEX version on request (see group 7)
- ▶ Threaded inserts version on request

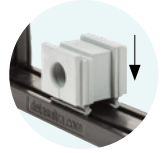
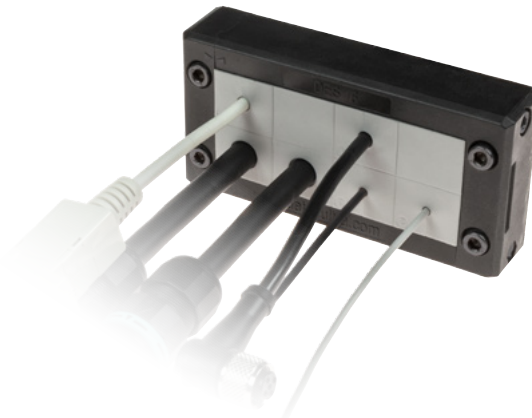

Model	Code	Some possible configurations	Max. cut-out [mm]	Pcs /pack
DES 16	1731010016		86 x 39	10
Upon request:	1731991020	Set of 4 mounting screws in AISI304 with Black Dacromet finishing		

The DES 16 cable entry system consists of a splittable frame designed to accommodate small (SPP), multiple (X) or large (SPG) grommets for cables with and without connectors. The grommets can be freely positioned into the frame.

With all combinations of grommets, single, double, quadruple, big, the IP66 and NEMA 4X* are guaranteed.

The overmolded gasket guarantees faster installation times and the complete V0 self-extinguishing of the system.

Technical data

Material: PP+GF

Flammability: self-extinguishing acc. to UL94-V0

Temperature: -40°C... +155°C (static)

Features: halogens and silicones free

Related products

SPP grommets (from page 43)

SPG grommets (from page 49)

DES Cover (page 24)

DES Flap (page 25)

HY360 hydraulic punch driver (page 129)

PF/PFX cable entry system plates (from page 130)

DES caps (page 58)

Intumescent gasket (page 117)

Dimensions [mm]

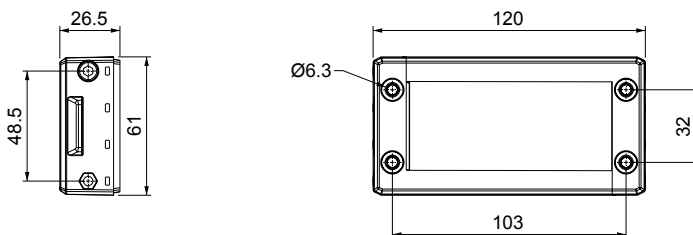

* Indoor only



IP66

NEMA 12, 4X*

UL TYPE 12, 4X



ECOLAB



IK10





Splittable frame for cables with and without connectors

- ▶ Multiple configurations in the same frame
- ▶ Frame screws in AISI304 Stainless Steel
- ▶ IP66 and NEMA 4X* certified with all configurations of grommets
- ▶ Strain relief according to EN 62444
- ▶ Sturdy construction IK10
- ▶ Overmolded gasket acc. to UL94-V0
- ▶ ATEX version on request (see group 7)
- ▶ Threaded inserts version on request

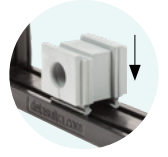
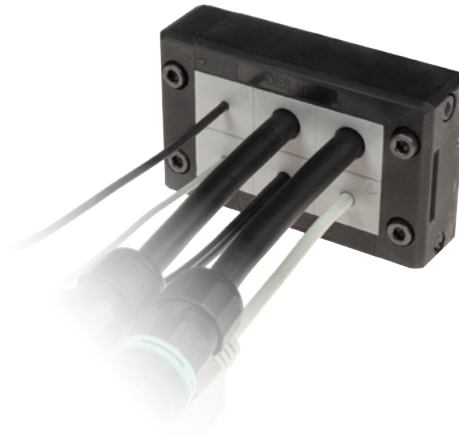

Model	Code	Some possible configurations	Max. cut-out [mm]	Pcs /pack
DES 10	1731010010		63 x 39	10
Upon request:	1731991020	Set of 4 mounting screws in AISI304 with Black Dacromet finishing		

The DES 10 cable entry system consists of a splittable frame designed to accommodate small (SPP), multiple (X) or large (SPG) grommets for cables with and without connectors. The grommets can be freely positioned into the frame.

With all combinations of grommets, single, double, quadruple, big, the IP66 and NEMA 4X* are guaranteed.

The overmolded gasket guarantees faster installation times and the complete V0 self-extinguishing of the system.

Technical data

Material: PP+GF

Flammability: self-extinguishing acc. to UL94-V0

Temperature: -40°C... +155°C (static)

Features: halogens and silicones free

Related products

SPP grommets (from page 43)

SPG grommets (from page 49)

DES Cover (page 24)

DES Flap (page 25)

HY360 hydraulic punch driver (page 129)

DES caps (page 58)

Intumescent gasket (page 117)

Dimensions [mm]

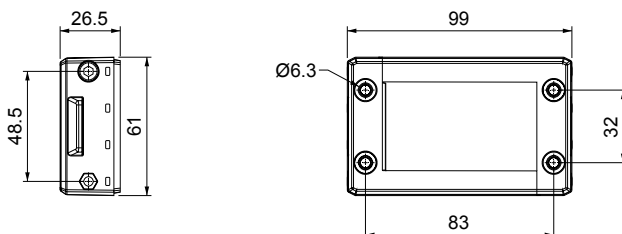

* Indoor only





Splittable frame for cables with and without connectors

- ▶ For 4 small grommets or 1 big grommet
- ▶ Frame screws in AISI304 Stainless Steel
- ▶ IP66 and NEMA 4X* certified with all configurations of grommets
- ▶ Strain relief according to EN 62444
- ▶ Sturdy construction IK10
- ▶ Overmolded gasket acc. to UL94-V0
- ▶ ATEX version on request (see group 7)
- ▶ Threaded inserts version on request

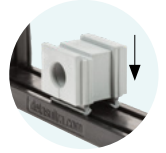
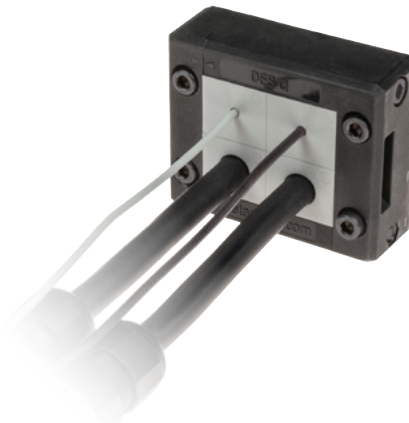

Model	Code	Some possible configurations	Max. cut-out [mm]	Pcs /pack
DES Q	1731010008		40 x 39	10

The DES Q cable entry system consists of a splittable frame designed to accommodate small (SPP), multiple (X) or large (SPG) grommets for cables with and without connectors. The grommets can be freely positioned into the frame.

With all combinations of grommets, single, double, quadruple, big, the IP66 and NEMA 4X* are guaranteed.

The overmolded gasket guarantees faster installation times and the complete V0 self-extinguishing of the system.

Technical data

Material: PP+GF

Flammability: self-extinguishing acc. to UL94-V0

Temperature: -40°C... +155°C (static)

Features: halogens and silicones free

Related products

SPP grommets (from page 43)

SPG grommets (from page 49)

DES Cover (page 24)

DES Flap (page 25)

HY360 hydraulic punch driver (page 129)

DES caps (page 58)

Intumescent gasket (page 117)

1

Upon request:	1731991020	Set of 4 mounting screws in AISI304 with Black Dacromet finishing
---------------	------------	---

Dimensions [mm]

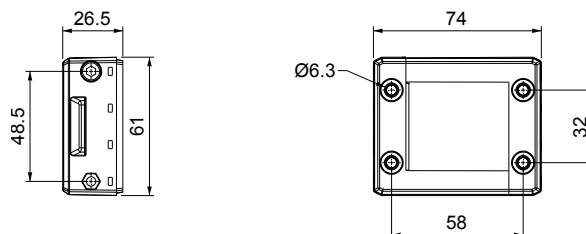

* Indoor only



IP66

NEMA 12, 4X*

UL TYPE 12, 4X



ECOLAB



RoHS COMPLIANT

IK10





Splittable frame for cables with and without connectors

- ▶ For 2 or 3 small SPP grommets
- ▶ Frame screws in AISI304 Stainless Steel
- ▶ IP66 and NEMA 4X* certified with all configurations of grommets
- ▶ Strain relief according to EN 62444
- ▶ Sturdy construction IK10
- ▶ Overmolded gasket acc. to UL94-V0
- ▶ ATEX version on request (see group 7)
- ▶ Threaded inserts version on request



Model	Code	Some possible configurations	Max. cut-out [mm]	Pcs /pack
DES L2	1731010002		40 x 18	10
DES L3	1731010003		63 x 18	
Upon request:	1731991010	Set of 2 mounting screws in AISI304 with Black Dacromet finishing		

The DES L2/L3 cable entry system consists of a splittable frame designed to accommodate small (SPP) grommets for cables with or without connectors.

With all combinations of grommets, single, double, quadruple, the IP66 and NEMA 4X* are guaranteed.

The overmolded gasket guarantees faster installation times and the complete V0 self-extinguishing of the system.

Technical data

Material: PP+GF

Flammability: self-extinguishing acc. to UL94-V0

Temperature: -40°C... +155°C (static)

Features: halogens and silicones free

Related products

SPP grommets (from page 43)

HY360 hydraulic punch driver (page 129)

DES caps (page 58)

Dimensions [mm]

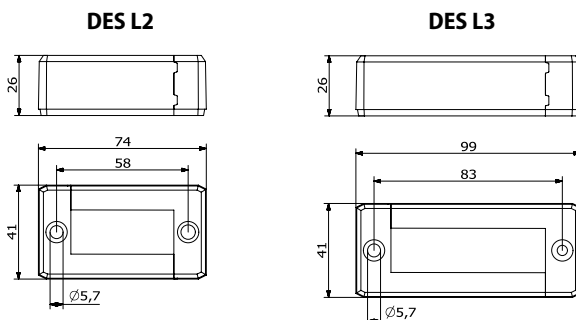

* Indoor only





DES L4/L5



Splittable frame for cables with and without connectors

- ▶ For 4 or 5 small SPP grommets
- ▶ Frame screws in AISI304 Stainless Steel
- ▶ IP66 and NEMA 4X* certified with all configurations of grommets
- ▶ Strain relief according to EN 62444
- ▶ Sturdy construction IK10
- ▶ Overmolded gasket acc. to UL94-V0
- ▶ ATEX version on request (see group 7)
- ▶ Threaded inserts version on request

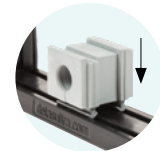
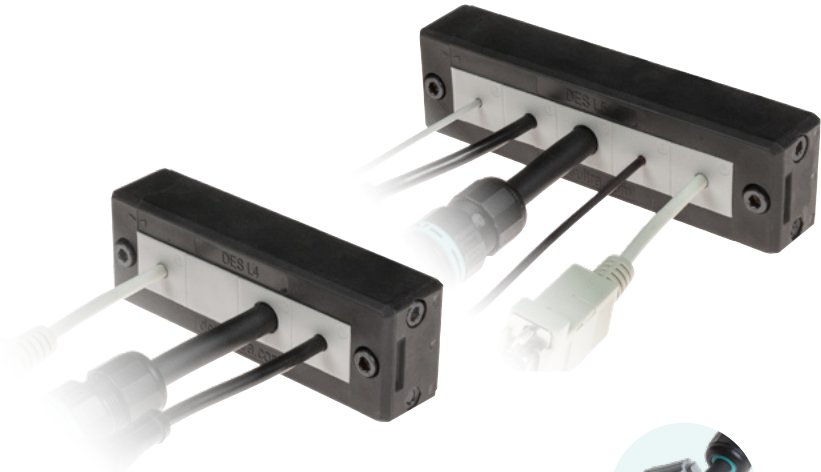

Model	Code	Some possible configurations	Max. cut-out [mm]	Pcs /pack
DES L4	1731010004		86 x 18	10
DES L5	1731010005		112 x 18	
Upon request:	1731991010	Set of 2 mounting screws in AISI304 with Black Dacromet finishing		

The DES L4/L5 cable entry system consists of a splittable frame designed to accommodate small (SPP) grommets for cables with or without connectors.

With all combinations of grommets, single, double, quadruple, the IP66 and NEMA 4X* are guaranteed.

The overmolded gasket guarantees faster installation times and the complete V0 self-extinguishing of the system.

Technical data

Material: PP+GF

Flammability: self-extinguishing acc. to UL94-V0

Temperature: -40°C... +155°C (static)

Features: halogens and silicones free

Related products

SPP grommets (from page 43)

HY360 hydraulic punch driver (page 129)

DES caps (page 58)

Dimensions [mm]

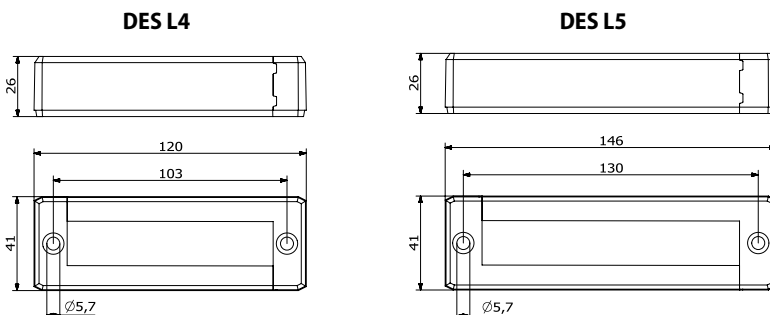

* Indoor only





Splittable frame with threaded inserts

- ▶ Flat surface without dirt deposit
- ▶ **Rear installation with M4 threaded inserts**
- ▶ IP66 and NEMA 4X* certified with all configurations of grommets
- ▶ Strain relief according to EN 62444
- ▶ Sturdy construction IK10
- ▶ Overmolded gasket acc. to UL94-V0



M4 threaded inserts



Model	Code	Example	Max. cut-out [mm]	Pcs /pack
DES L2 FT	1731410002		40x18	10
DES L3 FT	1731410003		63x18	
DES L4 FT	1731410004		86x18	
DES L5 FT	1731410005		112x18	
DES Q FT	1731410008		40x39	
DES 10 FT	1731410010		63x39	
DES 16 FT	1731410016		86x39	
DES 24 FT	1731410024		112x39	

The DES FT splittable frames are equipped with threaded inserts and with front taps which allow the installation on the rear part of the panel and keep the front part clean avoiding dirt accumulation.

All the other technical data of the DES FT frames are exactly the same of DES Series.

Technical data

Material: PP+GF

Flammability: self-extinguishing acc. to UL94-V0

Temperature: -40°C... +155°C (static)

Features: halogens and silicones free

Related products

SPP grommets (from page 43)

SPG grommets (from page 49)

DES Cover (page 24)

DES Flap (page 25)

HY360 hydraulic punch driver (page 129)

PF/PFX cable entry system plates (from page 130)

DES caps (page 58)

1

* Indoor only





DES 24-90



Splittable frame for cables with and without connectors

- ▶ 90° cable entry
- ▶ Multiple configurations in the same frame
- ▶ Frame screws in AISI304 Stainless Steel
- ▶ IP54
- ▶ Strain relief according to EN 62444
- ▶ Sturdy construction IK10

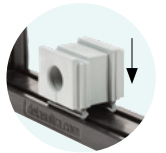

Model	Code	Some possible configurations	Max. cut-out [mm]	Pcs /pack
DES 24-90	1731010124		112 x 39	10

The 90° cable entry system DES24-90 is used when the machinery construction does not allow the straight cables entrance, or when a nice design is requested.

This cable entry system is suitable for both cables with or without connectors and corrugated conduits, or a mix of them. The grommets can be freely accommodated into the frame.

Technical data

Material: PP+GF

Flammability: self-extinguishing acc. to UL94-V0

Temperature: -40°C... +155°C (static)

Features: halogens and silicones free

Related products

SPP grommets (from page 43)

SPG grommets (from page 49)

DES Cover (page 24)

HY360 hydraulic punch driver (page 129)

Dimensions [mm]

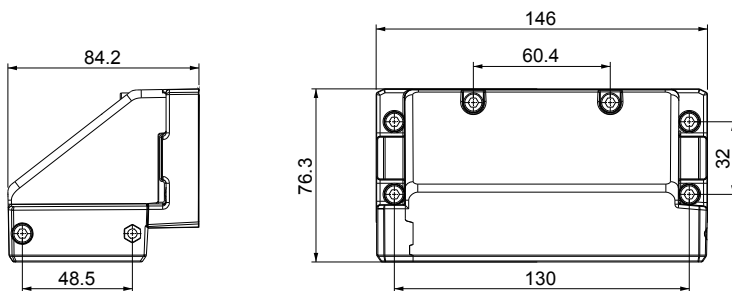

IP54

NEMA 12

UL TYPE 12



ECOLAB



IK10



DES 24M



Splittable frame for cables with and without connectors

- ▶ Multiple configurations with small and big grommets
- ▶ Frame screws in AISI304 Stainless Steel
- ▶ External gasket included
- ▶ Strain relief according to EN 62444
- ▶ Sturdy construction IK10
- ▶ Threaded inserts version on request

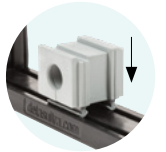

Model	Code	Some possible configurations	Max. cut-out [mm]	Pcs /pack
DES 24M	1731010224		114 x 40	10
Upon request:	1731991020	Set of 4 mounting screws in AISI304 with Black Dacromet finishing		

The DES 24M splittable frame allow up to 40 cables with or without connector or one or two cables up to 35mm diameter to pass through electric cabinet or machines walls.

The small and big grommets can be freely positioned inside the frame.

The DES 24M frame is the base structure for the expandable MX version.

Technical data

Material: PP+GF

Flammability: self-extinguishing acc. to UL94-V0

Temperature: -40°C... +155°C (static)

Features: halogens and silicones free

Related products

SPP grommets (from page 43)

SPG grommets (from page 49)

DES Cover (page 24)

HY360 hydraulic punch driver (page 129)

PF/PFX cable entry system plates (from page 130)

DES caps (page 58)

Dimensions [mm]

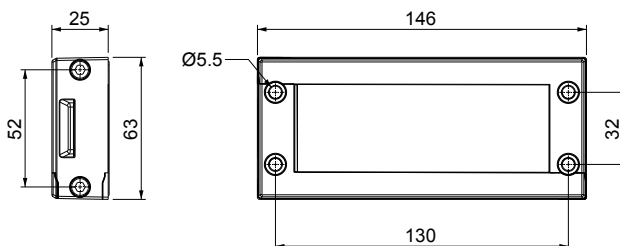

IP54

NEMA 12



ECOLAB



IK10





DES 24MX15

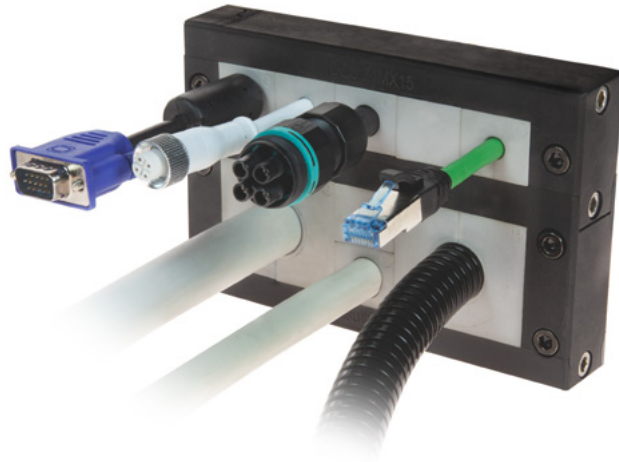

Splittable frame for cables with and without connectors

- ▶ Multiple configurations in the same frame
- ▶ Frame screws in AISI304 Stainless Steel
- ▶ Degree of protection IP54
- ▶ Strain relief acc. to EN 62444
- ▶ Sturdy construction IK10
- ▶ External gasket included
- ▶ Threaded inserts version on request

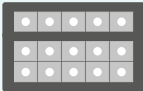
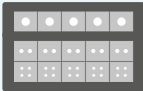
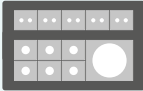
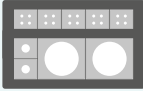

Model	Code	Some possible configurations	Dimensions L x H [mm]	Max. cut-out. [mm]	Pz x conf.
 DES 24MX15	1731010215	   	146 x 95,4	114 x 70	1
Upon request:	1731991020	Set of 4 mounting screws in AISI304 with Black Dacromet finishing			

The DES 24MX15 splittable frame allow up to 60 cables with or without connector or one or two cables up to 35mm diameter to pass through electric cabinet or machines walls.

The small and big grommets can be freely positioned inside the frame.

The DES 24MX15 is closed thanks to three stainless steel screws on the right side.

Technical data

Material: PP+GF

Flammability: self-extinguishing acc. to UL94-V0

Temperature: -40°C... +155°C (static)

Features: halogens and silicones free

Related products

SPP grommets (from page 43)

SPG grommets (from page 49)

Dimensions [mm]

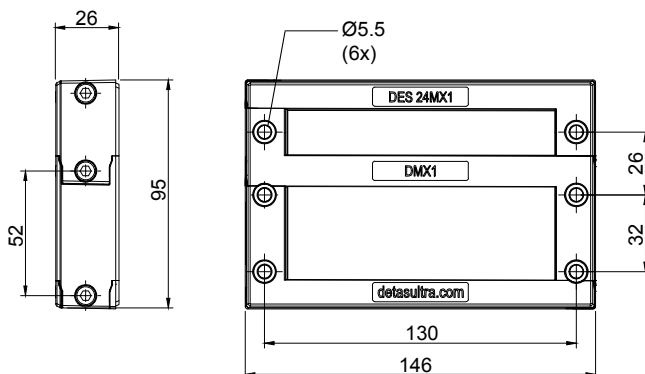

IP54

NEMA 12



ECOLAB









IK10

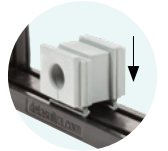

Modular frames for cables with and without connectors

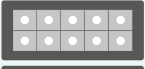
- ▶ Multiple configurations with small and big grommets
- ▶ Frame screws in AISI304 Stainless Steel
- ▶ IP54
- ▶ Strain relief according to EN 62444
- ▶ Sturdy construction IK10
- ▶ External gasket included

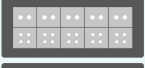

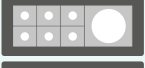
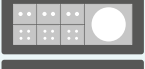
Model	Code	Some possible configurations per module	Dimensions L x H [mm]	Max. cut-out [mm]	Pcs /pack
 DES 24MX2	1731010252		146 x 115	114 x 92	1
 DES 24MX3	1731010253				
 DES 24MX4	1731010254		146 x 166	114 x 144	
					
Other models upon request					

Upon request:	1731991020	Set of 4 mounting screws in AISI304 with Black Dacromet finishing
---------------	------------	---

The DES 24MX splittable frames family is a modular solution for installations where a big quantity of cables need to be routed through electrical cabinets walls or machines.

This solution is not only modular but it is also a general solution that can be adopted as main cables entrance. Both cables with or without connector can be routed (40 for each module) and future updates can easily be organized in the cheapest and fastest way.

Technical data

Material: PP+GF

Flammability: self-extinguishing acc. to UL94-V0

Temperature: -40°C... +155°C (static)

Features: halogens and silicones free

Related products

SPP grommets (from page 43)

SPG grommets (from page 49)

PF/PFX cable entry system plates (from page 130)

DES caps (page 58)

Dimensions [mm]

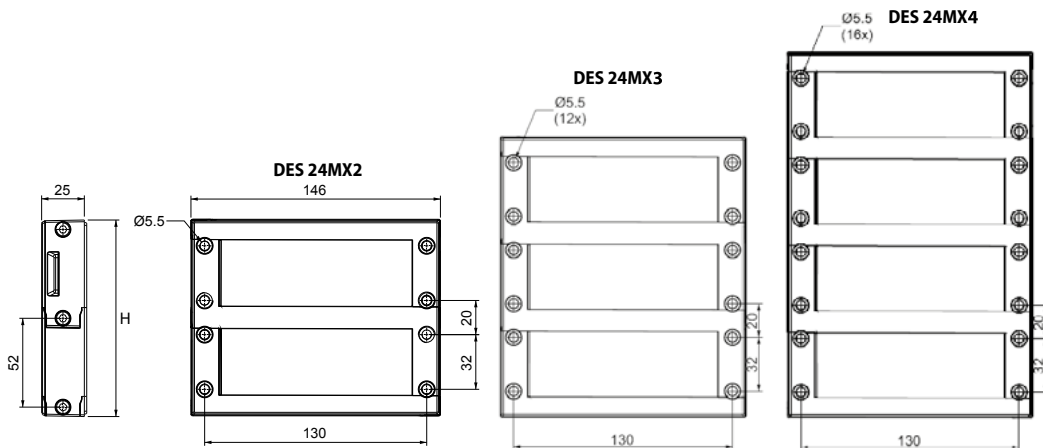

IP54

NEMA 12



ECOLAB



IK10



DES 16M



Splittable frame for cables with and without connectors

- ▶ Multiple configurations with small and big grommets
- ▶ Frame screws in AISI304 Stainless Steel
- ▶ External gasket included
- ▶ Strain relief according to EN 62444
- ▶ Sturdy construction IK10
- ▶ Threaded inserts version on request

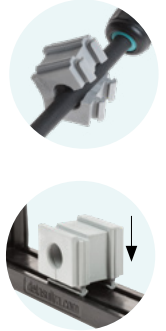

Model	Code	Some possible configurations	Max. cut-out [mm]	Pcs /pack
DES 16M	1731010216		86 x 40	10
Upon request:	1731991020	Set of 4 mounting screws in AISI304 with Black Dacromet finishing		

The DES 16M splittable frame allow up to 32 cables with or without connector or one or two cables up to 35mm diameter to pass through electric cabinet or machines walls.

The small and big grommets can be freely positioned inside the frame.

The DES 16M frame is the base structure for the expandable MX version.

Technical data

Material: PP+GF

Flammability: self-extinguishing acc. to UL94-V0

Temperature: -40°C... +155°C (static)

Features: halogens and silicones free

Related products

SPP grommets (from page 43)

SPG grommets (from page 49)

DES Cover (page 24)

HY360 hydraulic punch driver (page 129)

DES caps (page 58)

Dimensions [mm]

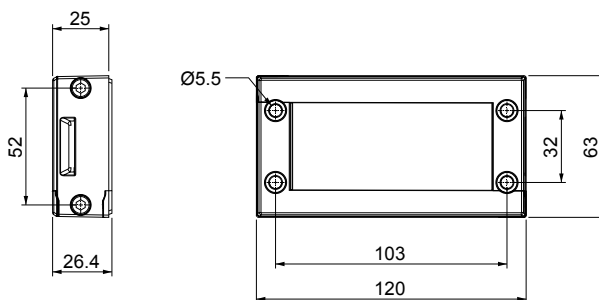

IP54

NEMA 12



ECOLAB



IK10



Modular frames for cables with and without connectors

- ▶ Multiple configurations with small and big grommets
- ▶ Frame screws in AISI304 Stainless Steel
- ▶ IP54
- ▶ Strain relief according to EN 62444
- ▶ Sturdy construction IK10
- ▶ External gasket included

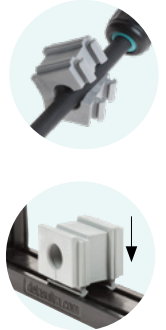

Model	Code	Some possible configurations per module	Dimensions L x H [mm]	Max. cut-out [mm]	Pcs /pack
DES 16MX2	1731010262		120 x 115	86 x 92	1
DES 16MX3	1731010263		120 x 167	86 x 144	
DES 16MX4	1731010264		120 x 219	86 x 196	

Other models upon request

Upon request:	1731991020	Set of 4 mounting screws in AISI304 with Black Dacromet finishing
---------------	------------	---

The DES 16MX splittable frames family is a modular solution for installations where a big quantity of cables need to be routed through electrical cabinets walls or machines.

This solution is not only modular but it is also a general solution that can be adopted as main cables entrance. Both cables with or without connector can be routed (32 for each module) and future updates can easily be organized in the cheapest and fastest way.

Technical data

Material: PP+GF

Flammability: self-extinguishing acc. to UL94-V0

Temperature: -40°C... +155°C (static)

Features: halogens and silicones free

Related products

SPP grommets (from page 43)

SPG grommets (from page 49)

DES caps (page 58)

Dimensions [mm]

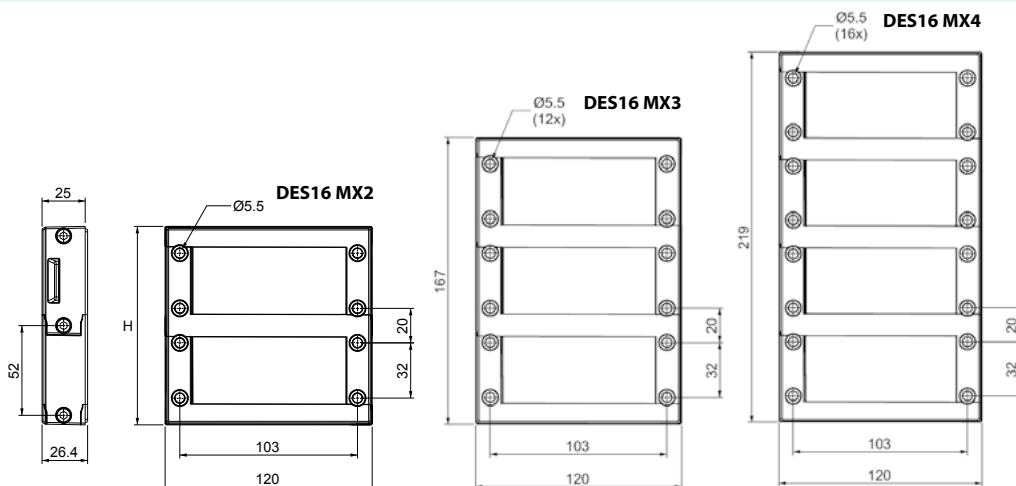

IP54

NEMA 12



ECOLAB



IK10



DES 24 CLICK



Splittable frame for cables with and without connectors

- ▶ For small and big grommets
- ▶ Without screws, snap closing
- ▶ Strain relief according to EN 62444
- ▶ Compact size
- ▶ IP54
- ▶ External gasket acc. to UL94-V0 included
- ▶ Threaded inserts version on request
- ▶ UL94-V0 for both grey and black grommets



Model	Code	Some possible configurations	Max. cut-out [mm]	Pcs /pack
DES 24 CLICK	1731010324		112 x 36	10
Upon request:	1731991020	Set of 4 mounting screws in AISI304 with Black Dacromet finishing		

The DES 24 CLICK splittable frame allows to accommodate up to 40 cables with or without connectors with diameters from 2 to 31 mm. The frame closing is made through two side hooks. Despite the absence of screws, the mechanical seal on the cable is perfect. The frame accepts 10 small grommets or 1 big grommet and 6 small grommets.

Technical data

Material: PC+GF

Flammability: self-extinguishing acc. to UL94-V0

Temperature: -40°C... +155°C (static)

Features: halogens and silicones free

Related products

SPC grommets (page 39)

SPL grommets (from pages 41)

HY360 hydraulic punch driver (page 129)

PF/PFX cable entry system plates (from page 130)

Dimensions [mm]

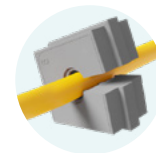
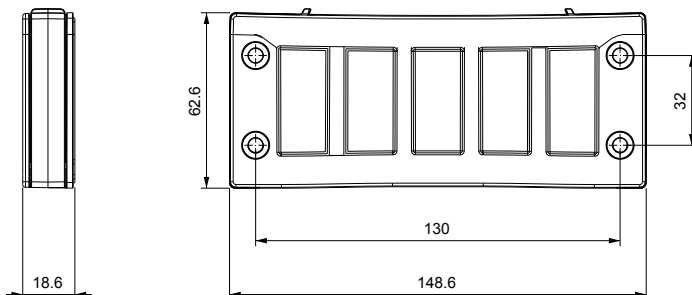

IP54

NEMA 12

ECOLAB



IK10



Splittable frame for cables with and without connectors

- ▶ For small and big grommets (same frame)
- ▶ Without screws, snap closing
- ▶ Strain relief according to EN 62444
- ▶ Compact size
- ▶ IP54
- ▶ External gasket acc. to UL94-V0 included
- ▶ Threaded inserts version on request
- ▶ UL94-V0 for both grey and black grommets



Model	Code	Some possible configurations	Max. cut-out [mm]	Pcs /pack
DES 16 CLICK	1731010316		86 x 36	10
Upon request:	1731991020	Set of 4 mounting screws in AISI304 with Black Dacromet finishing		

The DES 16 CLICK splittable frame allows to accommodate up to 32 cables with or without connectors with diameters from 2 to 32 mm. The frame closing is made through two side hooks. Despite the absence of screws, the mechanical seal on the cable is perfect. The frame accepts 8 small grommets or 1 big grommet and 4 small grommets.

Technical data

Material: PC+GF

Flammability: self-extinguishing acc. to UL94-V0

Temperature: -40°C... +155°C (static)

Features: halogens and silicones free

Related products

SPC grommets (page 39)

SPL grommets (from pages 41)

HY360 hydraulic punch driver (page 129)

PF/PFX cable entry system plates (from page 130)

1

Dimensions [mm]

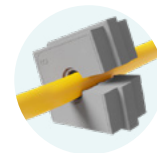
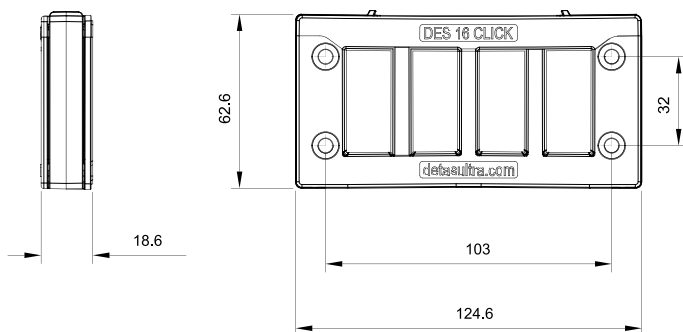



DES 10 CLICK



Splittable frame for cables with and without connectors

- ▶ For small and big grommets (same frame)
- ▶ Without screws, snap closing
- ▶ Strain relief according to EN 62444
- ▶ Compact size
- ▶ IP54
- ▶ External gasket acc. to UL94-V0 included
- ▶ Threaded inserts version on request
- ▶ UL94-V0 for both grey and black grommets



Model	Code	Some possible configurations	Max. cut-out [mm]	Pcs /pack
DES 10 CLICK	1731010310		63 x 36	10
Upon request:	1731991020	Set of 4 mounting screws in AISI304 with Black Dacromet finishing		

The DES 10 CLICK splittable frame allows to accommodate up to 24 cables with or without connectors with diameters from 2 to 32 mm. The frame closing is made through two side hooks. Despite the absence of screws, the mechanical seal on the cable is perfect. The frame accepts 6 small grommets or 1 big grommet and 2 small grommets.

Technical data

Material: PC+GF

Flammability: self-extinguishing acc. to UL94-V0

Temperature: -40°C... +155°C (static)

Features: halogens and silicones free

Related products

SPC grommets (page 39)

SPL grommets (from pages 41)

HY360 hydraulic punch driver (page 129)

PF/PFX cable entry system plates (from page 130)

Dimensions [mm]

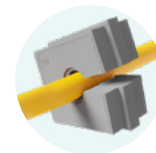
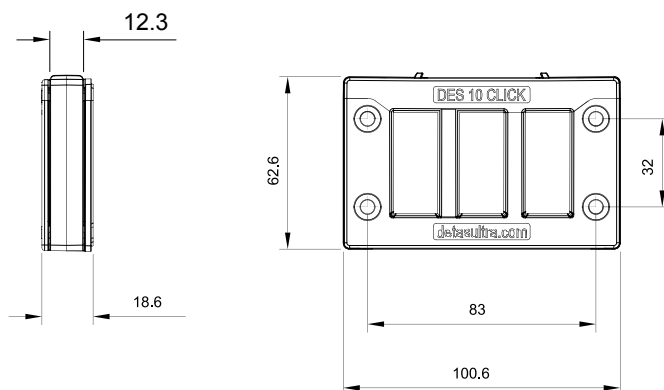

IP54

NEMA 12

ECOLAB



RoHS COMPLIANT

IK10



Splittable frame for cables with and without connectors

- ▶ For small and big grommets (same frame)
- ▶ Without screws, snap closing
- ▶ Strain relief according to EN 62444
- ▶ Compact size
- ▶ IP54
- ▶ External gasket acc. to UL94-V0 included
- ▶ Threaded inserts version on request
- ▶ UL94-V0 for both grey and black grommets

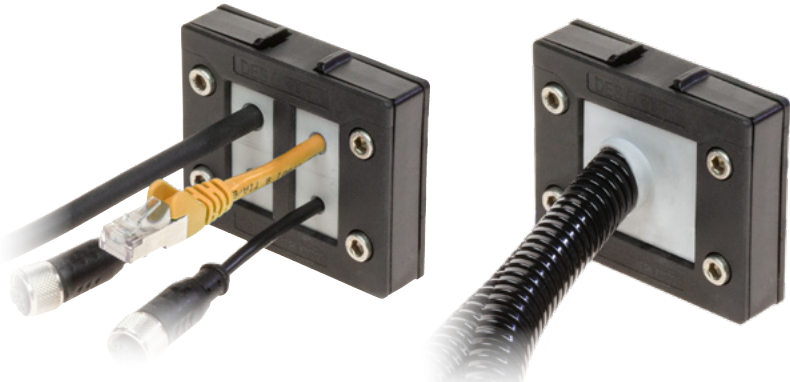

Model	Code	Some possible configurations	Max. cut-out [mm]	Pcs /pack
DES Q CLICK	1731010308		40 x 36	10
Upon request:	1731991020	Set of 4 mounting screws in AISI304 with Black Dacromet finishing		

The DES Q CLICK splittable frame allows to accommodate up to 16 cables with or without connectors with diameters from 2 to 32 mm. The frame closing is made through two side hooks. Despite the absence of screws, the mechanical seal on the cable is perfect. The frame accepts 4 small grommets or 1 big grommet.

Technical data

Material: PC+GF

Flammability: self-extinguishing acc. to UL94-V0

Temperature: -40°C... +155°C (static)

Features: halogens and silicones free

Related products

SPC grommets (page 39)

SPL grommets (from pages 41)

HY360 hydraulic punch driver (page 129)

PF/PFX cable entry system plates (from page 130)

1

Dimensions [mm]

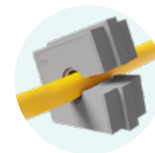
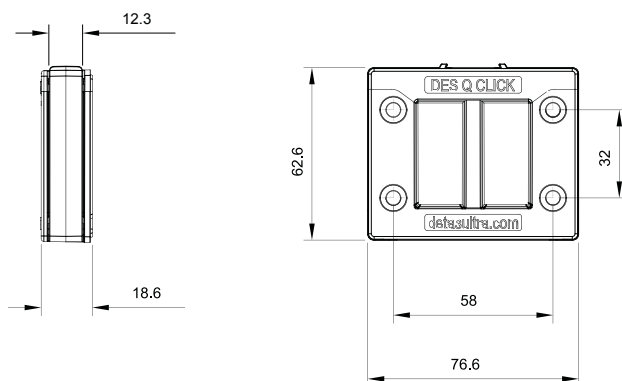





DES 380M

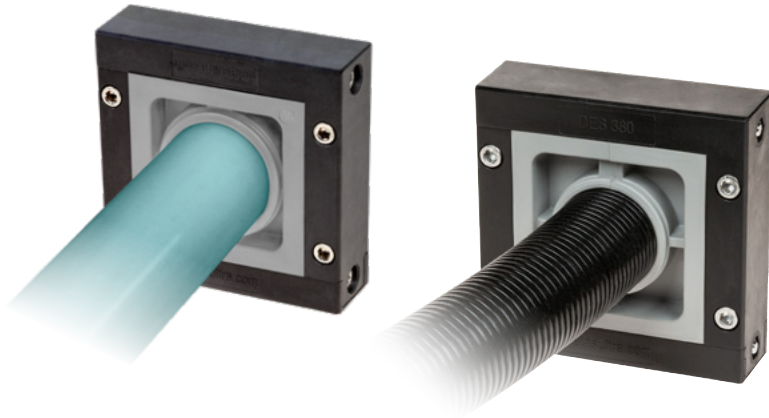

Modular frames for big diameter cables or corrugates tubes

- ▶ Fast and easy fixing of big diameter cables and corrugated pipes
- ▶ Diameters from 36 to 65 mm
- ▶ Free installation on 4 sides
- ▶ IP54
- ▶ Sturdy construction IK10
- ▶ No need of gasket
- ▶ AISI 304 screws



Model	Code	Dimensions L x H [mm]	Max. cut-out [mm]	Pcs /pack
DES 380M 	1731010270	116 x 116	72 x 72	1

The DES 380 splittable frame family includes the DES 380M and MX and is a modular solution for big size cables and corrugated pipes installations on electrical cabinets or machinery.

The system allows cable or corrugated pipes with diameter from 36 to 66 mm diameter to be secured in the cabinet entrance with fast and strain relief fixing.

The DES 380M is the base product for increasing the number of cables thanks to the modular capabilities of the 380 MX system.

Technical data

Material: PP+GF

Flammability: self-extinguishing acc. to UL94-V0

Temperature: -40°C... +155°C (static)

Features: halogens and silicones free

Related products

SPH grommets (page 57)

PF/PFX cable entry system plates (from page 130)

1

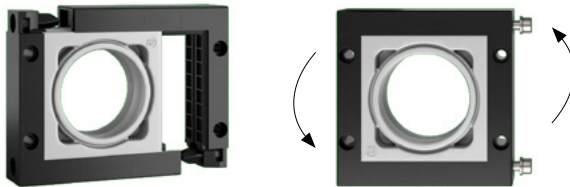

Dimensions [mm]

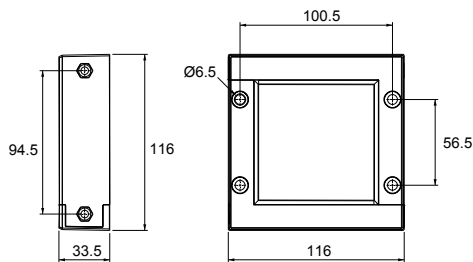

IP54

NEMA 12



ECOLAB







IK10

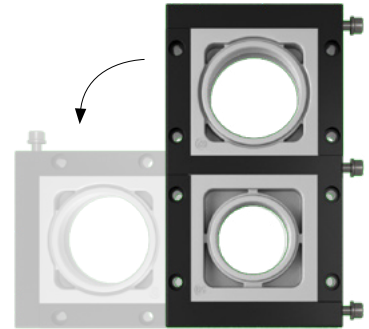
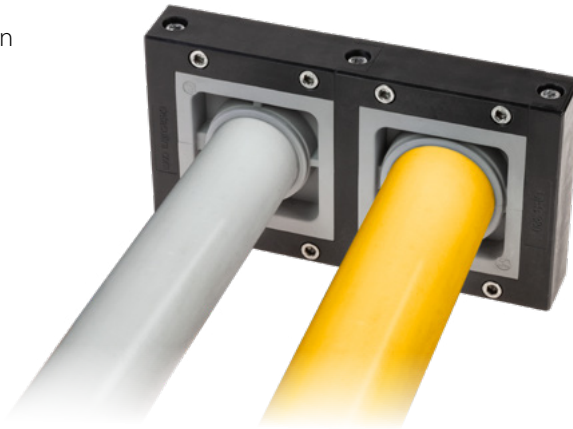

Modular frames for big diameter cables or corrugates tubes

- ▶ Fast and easy fixing of big diameter cables and corrugated pipes
- ▶ Modular system
- ▶ Diameters from 36 to 65 mm
- ▶ Horizontal or vertical installation
- ▶ IP54
- ▶ No need of gasket
- ▶ AISI 304 screws



Model	Code	Dimensions L x H [mm]	Max. cut-out [mm]	Pcs /pack
DES 380MX2 	1731010272	210,5 x 116	166,5 x 72	1
DES 380MX3 	1731010273	305 x 116	261 x 72	
DES 380MX4 	1731010274	399,5 x 116	355,5 x 72	

Other models upon request

The splittable DES 380MX frames are used for routing big diameter cables and corrugated pipes through electric, machinery or main cabinets.

The solution is modular meaning that the customer can buy the 4 frames solution for using them for 4 or less cables. Then he can add an accessory and increase easily the number of cables limitless.

Technical data

Material: PP+GF

Flammability: self-extinguishing acc. to UL94-V0

Temperature: -40°C... +155°C (static)

Features: halogens and silicones free

Related products

SPH grommets (page 57)

PF/PFX cable entry system plates (from page 130)

Dimensions [mm]

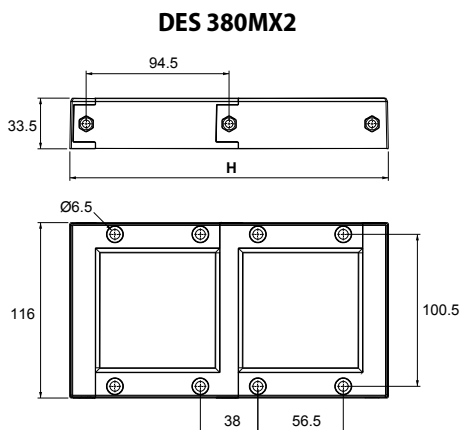



DES COVER



Sealing plates for DES series

- ▶ Fast installation
- ▶ Gasket acc. to UL94-V0 included
- ▶ Same holes position of the DES Systems
- ▶ IP66



Model	Code	Dimensions [mm]		Pcs /pack
		L1	L2	
DES COVER 24	1731032024	146	130	10
DES COVER 16	1731032016	120	103	
DES COVER 10	1731032010	99	83	
DES COVER Q	1731032008	74	58	
Upon request:	1731991020	Set of 4 mounting screws in AISI304 with Black Dacromet finishing		

The DES COVER plates allow to protect the unused gaps in the cabinet, avoiding contact with the outer environment.

Technical data

Material: PP+GF

Flammability: self-extinguishing acc. to UL94-V0

Temperature: -40°C... +155°C (static)

Features: halogens and silicones free

Related products

DES 24

DES 16

DES 10

DES Q

1

Dimensions [mm]

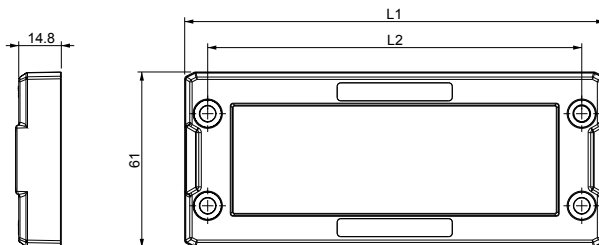

IP66

NEMA 12

ECOLAB

UL94-V0

UV ISO 4892-2A

RoHS COMPLIANT



Fast fixing solution for DES splittable frames

- ▶ Snap fixing for the DES Series
- ▶ Gasket included
- ▶ Same holes position of the DES Systems
- ▶ IP54



Model	Code	Dimensions [mm]		Max. cut-out [mm]	Pcs /pack
		L1	L2		
DES FLAP 24	1731031024	153	130	112 x 39	10
DES FLAP 16	1731031016	127	103	86 x 39	
DES FLAP 10	1731031010	106	83	63 x 39	
DES FLAP Q	1731031008	81	58	40 x 39	

The DES FLAP solution enables the DES 24, 16, 10 and Q frames to be installed with a quick snap-in connection.

The FLAP frame, once installed, hooks over the split frame and is the best solution for a flexible installation. Enclosures can be later inspected quickly and easily be dismantled.

Technical data

Material: PP+GF

Flammability: self-extinguishing acc. to UL94-V0

Temperature: -40°C... +155°C (static)

Features: halogens and silicones free

Related products

- DES 24
- DES 16
- DES 10
- DES Q
- DES Cover (page 24)
- PF cable entry system plates (page 130)

1

Dimensions [mm]

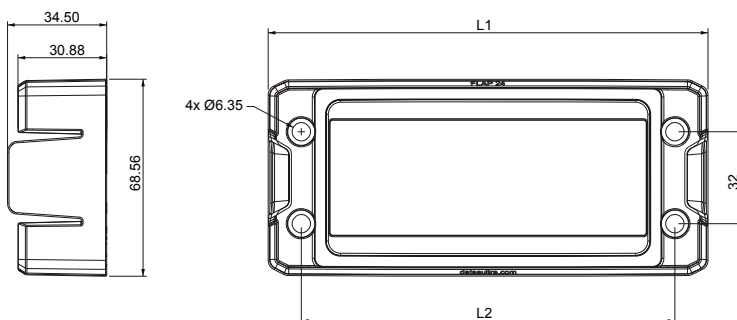

IP54

NEMA 12

UL TYPE 12



ECOLAB

UL94-V0



RoHS COMPLIANT



DES FLAP CLICK



Fast fixing solution for DES CLICK splittable frames

- ▶ Snap fixing for the DES Series
- ▶ Gasket acc. to UL94-V0 included
- ▶ Same holes position of the DES Systems
- ▶ IP54

NEW



Model	Code	Dimensions [mm]		Max. cut-out [mm]	Pcs /pack
		L1	L2		
DES FLAP 24 CLICK	1731010424	156,6	68,1	112 x 39	10
DES FLAP 16 CLICK	1731010416	132,6	68,1	86 x 39	
DES FLAP 10 CLICK	1731010410	109	68,1	63 x 39	
DES FLAP Q CLICK	1731010408	84,6	68,1	40 x 39	

The DES FLAP CLICK solution enables the DES 24, 16, 10 Q CLICK frames to be installed with a quick snap-in connection.

The FLAP CLICK frame, once installed, hooks over the split frame and is the best solution for a flexible installation.

Enclosures can be inspected quickly and easily.

Technical data

Material: PC+GF

Flammability: self-extinguishing acc. to UL94-V0

Temperature: -40°C... +155°C (static)

Features: halogens and silicones free

Related products

DES 24 CLICK

DES 16 CLICK

DES 10 CLICK

DES Q CLICK

1

Dimensions [mm]

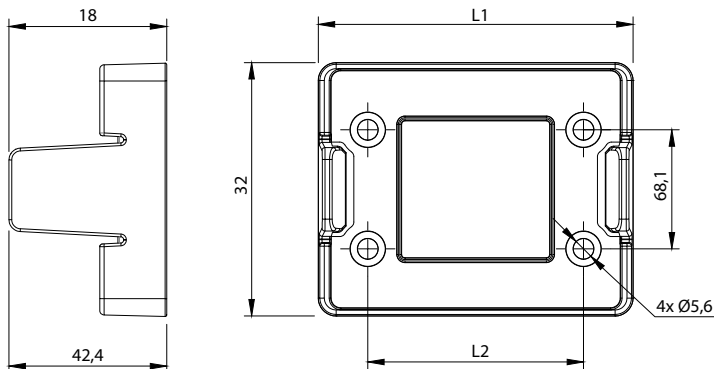

IP54

NEMA 12

UL TYPE 12

ECOLAB



Divisible cable glands

OSF

Snap mounting no screws

Versions with or without locknut

90° cable entry version

M16 / M20 / M25 / M32 / M40 / M50

IP54

For SPC / SPL grommets

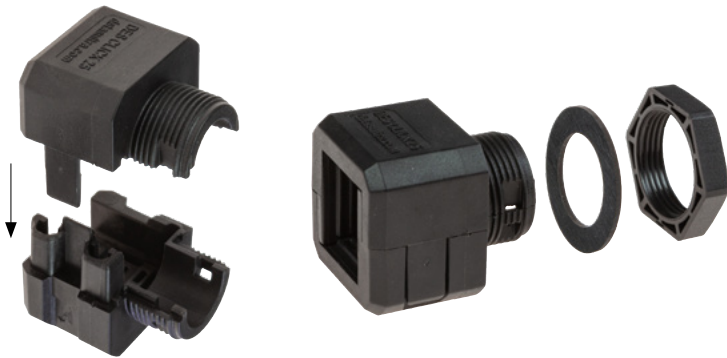
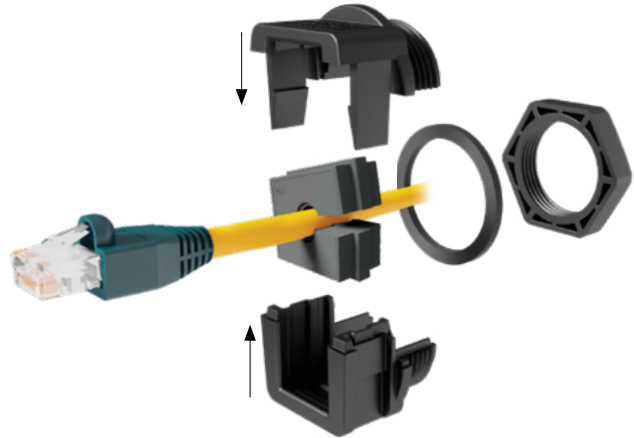

DESCCLICK

Snap mounting no screws

With locknut

M20 / M25 / M32 / M50

IP54

For SPP / SPG grommets

DESPRED

AISI316L Dacromet screws

With Locknut

M25 / M32 / M63

Up to 16 cables

IP66 - NEMA 4X

For SPP/SPG grommets

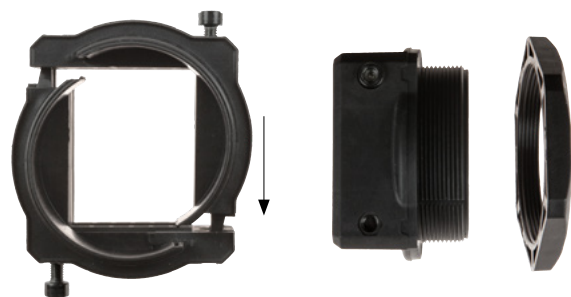



Divisible cable glands with locknut

- ▶ Metric sizes
- ▶ Without screws
- ▶ IP54
- ▶ Locknut and gasket included
- ▶ Available colors: grey and black

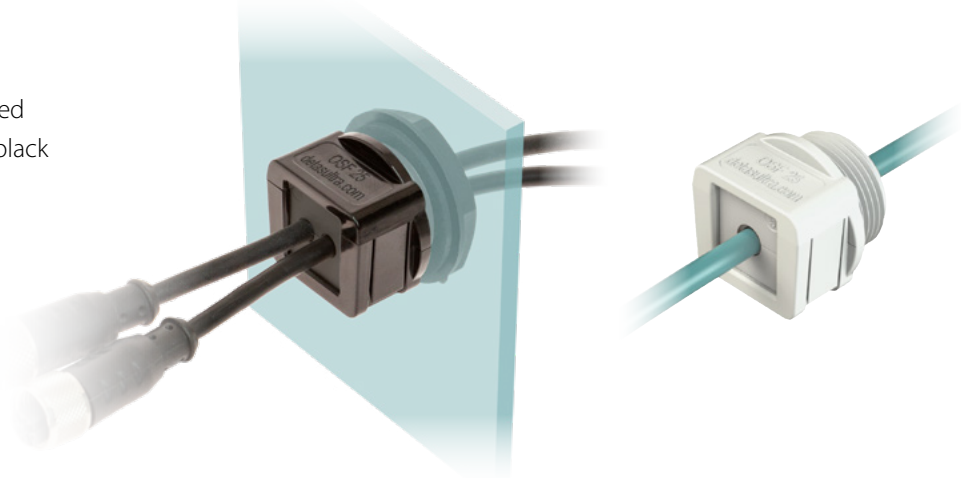

Model	Code	Max. grommet sizes			Cut-out Ø [mm]	Pcs /pack
		● ●	● ● ● ●	● ● ● ● ● ●		
OSF 16G	1731052316	SPC 10	SPC 2x4	SPC 4x4	16,5	10
OSF 20G	1731052320	SPC 14	SPC 2x5	SPC 4x5	20,5	
OSF 25G	1731052325	SPC 14	SPC 2x7	SPC 4x6	25,5	
OSF 32G	1731052332	SPC 14	SPC 2x7	SPC 4x6	32,5	
OSF 16B	1731052416	SPC 10	SPC 2x4	SPC 4x4	16,5	
OSF 20B	1731052420	SPC 14	SPC 2x5	SPC 4x5	20,5	
OSF 25B	1731052425	SPC 14	SPC 2x7	SPC 4x6	25,5	
OSF 32B	1731052432	SPC 14	SPC 2x7	SPC 4x6	32,5	

OSF is a divisible cable gland with metric thread especially designed for cables with connectors. The compact size and nice design are just a few of the countless advantages of the OSF Family. OSF can be equipped with SPC grommets with single or multiple holes for both black and grey UL94V0 colors.

Technical data

Material: PC

Flammability: self-extinguishing acc. to UL94-V0

Temperature: -40°C... +130°C (static)

Features: halogens and silicones free

Related products

Divisible locknuts (page 37-38)

SPC grommets (page 39)

OSF EMC (page 119)

HY360 hydraulic punch driver (page 129)

Dimensions [mm]

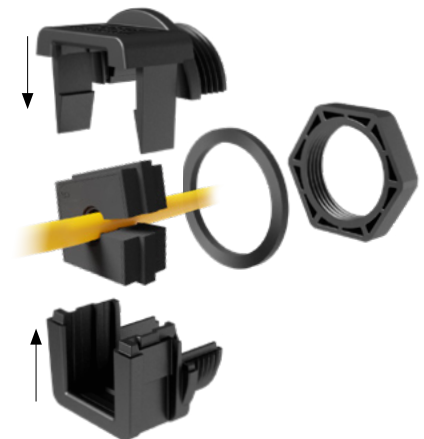
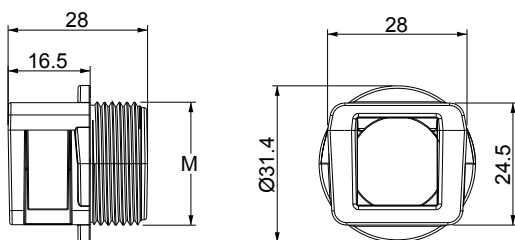

IP54

NEMA 12



IK10



Divisible cable gland with locknut

- ▶ M40 metric size
- ▶ Without screws
- ▶ IP54
- ▶ Locknut and gasket included
- ▶ Available colors: grey and black



Model	Code	Max. grommet sizes			Cut-out Ø [mm]	Pcs /pack
OSF40G	1731052340	SPC 14	SPC 2x7	SPC 4x6	40,5	10
OSF40B	1731052440	SPC 14	SPC 2x7	SPC 4x6		

Some possible configurations



OSF 40 is a divisible cable gland with metric thread especially designed for cables with connectors.

Is it possible to route up to 8 cables with connectors.

OSF 40 can be equipped with SPC grommets with single or multiple holes for both black and grey UL94V0 colors.

Technical data

Material: PC

Flammability: self-extinguishing acc. to UL94-V0

Temperature: -40°C... +130°C (static)

Features: halogens and silicones free

Related products

SPC grommets (page 39)

HY360 hydraulic punch driver (page 129)

Divisible locknuts (page 37-38)

Dimensions [mm]

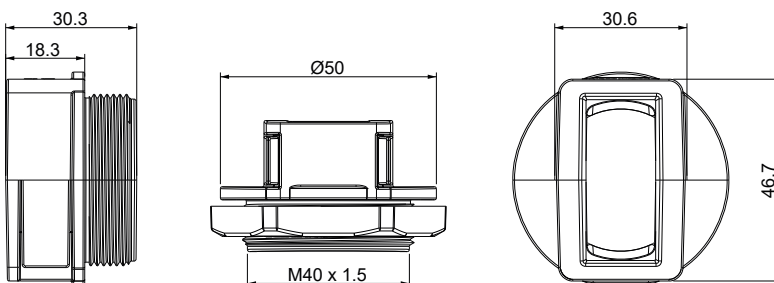



OSF50



Divisible cable gland with locknut

NEW

- ▶ M50 metric size
- ▶ Without screws
- ▶ IP54
- ▶ Locknut and gasket included
- ▶ Suitable for small or big grommets
- ▶ Available colors: grey and black

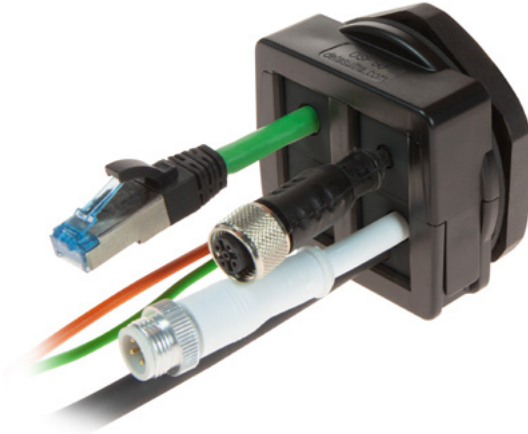

Model	Code	Max. grommet sizes			Cut-out Ø [mm]	Pcs pack
		SPC 14	SPC 2x6	SPC 4x6		
OSF50G	1731052350				50,5	10
OSF50B	1731052450					

Some possible configurations

OSF 50 is a divisible cable gland with metric thread especially designed for cables with connectors.

Is it possible to route up to 16 cables with connectors.

OSF 50 can be equipped in the same frame with SPC grommets with single or multiple holes from 2 to 14 mm diameter or with SPL grommets from 12 to 29 mm diameter. Both black and grey frame and grommets comply with UL94V0.

Technical data

Material: PC

Flammability: self-extinguishing acc. to UL94-V0

Temperature: -40°C... +130°C (static)

Features: halogens and silicones free

Related products

SPC grommets (page 39)

SPL grommets (page 41)

HY360 hydraulic punch driver (page 129)

Divisible locknuts (page 37-38)

Dimensions [mm]

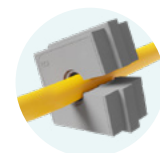
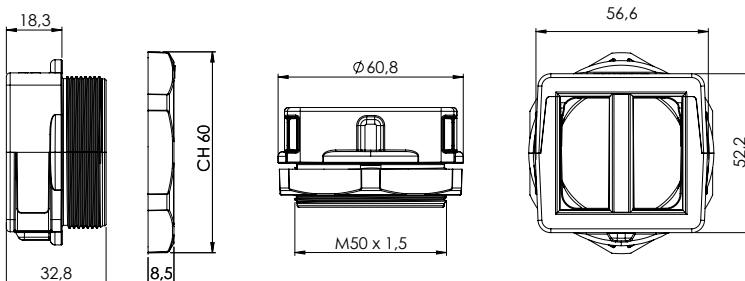

IP54

NEMA 12



ISO 4892-2A



IK10



Divisible cable glands with 90° entry

- ▶ 90° cable entry system
- ▶ Without screws
- ▶ IP54
- ▶ Locknut included
- ▶ Available colors: grey and black

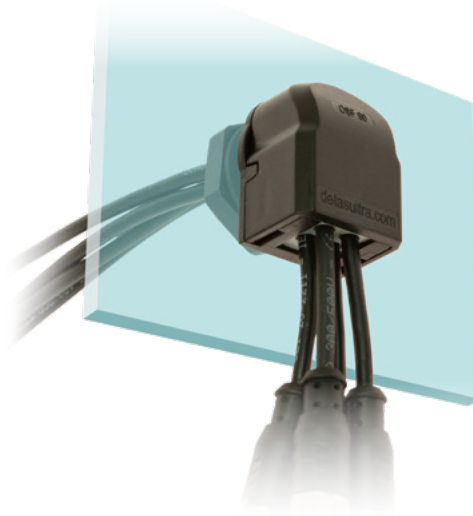

Model	Code	Max. grommet sizes			Cut-out Ø [mm]	Pcs /pack
OSF90 16G	1731052916	SPC 10	SPC 2x4	SPC 4x4	16,5	10
OSF90 20G	1731052920	SPC 10	SPC 2x5	SPC 4x5	20,5	
OSF90 25G	1731052925	SPC 10	SPC 2x7	SPC 4x6	25,5	
OSF90 32G	1731052932	SPC 10	SPC 2x7	SPC 4x6	32,5	
OSF90 16B	1731052917	SPC 10	SPC 2x4	SPC 4x4	16,5	
OSF90 20B	1731052921	SPC 10	SPC 2x5	SPC 4x5	20,5	
OSF90 25B	1731052926	SPC 10	SPC 2x7	SPC 4x6	25,5	
OSF90 32B	1731052933	SPC 10	SPC 2x7	SPC 4x6	32,5	

Cable bend radius max. 20 mm

OSF90 is a 90° divisible cable gland with metric thread especially designed for cables with connectors. The 90° entry systems nice looking gives more "design" to the machine or cabinet.

The compact size and nice design are only few advantages of the OSF Family.

OSF 90 can be equipped with SPC grommets with single or multiple holes for both black and grey UL94V0 colors.

Technical data

Material: PC

Flammability: self-extinguishing acc. to UL94-V0

Temperature: -40°C... +130°C (static)

Features: halogens and silicones free

Related products

SPC grommets (page 39)

Divisible locknuts (page 37-38)

OSF EMC (pag. 119)

HY360 hydraulic punch driver (page 129)

Dimensions [mm]

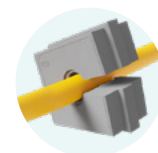
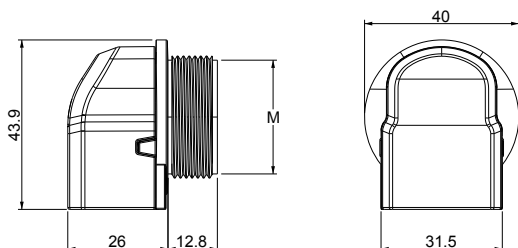



OSF ZIP



Divisible cable glands with snap mounting

- ▶ Without screws
- ▶ Snap mounting without locknut
- ▶ Wall thickness from 1,2 to 2 mm
- ▶ Gasket included
- ▶ IP54
- ▶ Grey or black version

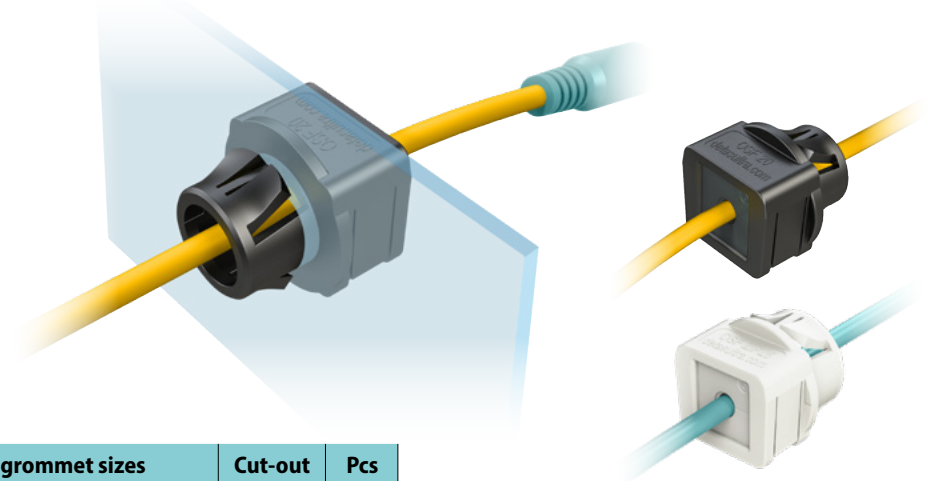

Model	Code	Max. grommet sizes			Cut-out Ø [mm]	Pcs /pack	
		● ●	● ● ● ●	● ● ● ● ● ●			
OSF ZIP 16G	1731052716	SPC 10	SPC 2x4	SPC 4x4	16,5	10	
OSF ZIP 20G	1731052720	SPC 14	SPC 2x5	SPC 4x5	20,5		
OSF ZIP 25G	1731052725	SPC 14	SPC 2x7	SPC 4x6	25,5		
OSF ZIP 32G	1731052732	SPC 14	SPC 2x7	SPC 4x6	32,5		
OSF ZIP 16B	1731052816	SPC 10	SPC 2x4	SPC 4x4	16,5		
OSF ZIP 20B	1731052820	SPC 14	SPC 2x5	SPC 4x5	20,5		
OSF ZIP 25B	1731052825	SPC 14	SPC 2x7	SPC 4x6	25,5		
OSF ZIP 32B	1731052832	SPC 14	SPC 2x7	SPC 4x6	32,5		
Disassembly bracket							
OSF ZH16	1731052850						
OSF ZH20	1731052851						
OSF ZH25	1731052852						
OSF ZH32	1731052853						

OSF ZIP is a divisible cable gland for metric holes especially designed for cables with connectors. The installation can be made only from the front since no locknut is required.

OSF ZIP can be equipped with SPC grommets with single, double or quadruple holes from 2 to 14 mm diameter.

Technical data

Material: PC

Flammability: self-extinguishing acc. to UL94-V0

Temperature: -40°C... +130°C (static)

Features: halogens and silicones free

Related products

SPC grommets (page 39)

HY360 hydraulic punch driver (page 129)

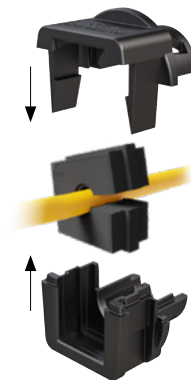

Dimensions [mm]

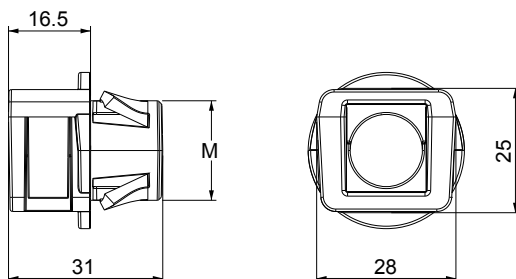

IP54

NEMA 12



IK10



Divisible cable glands with locknut

- ▶ Without screws
- ▶ Metric sizes: M20, M25 and M32
- ▶ Strain relief according to EN 62444
- ▶ Sturdy construction IK10
- ▶ IP54
- ▶ Locknut and gasket included
- ▶ Grey or black version

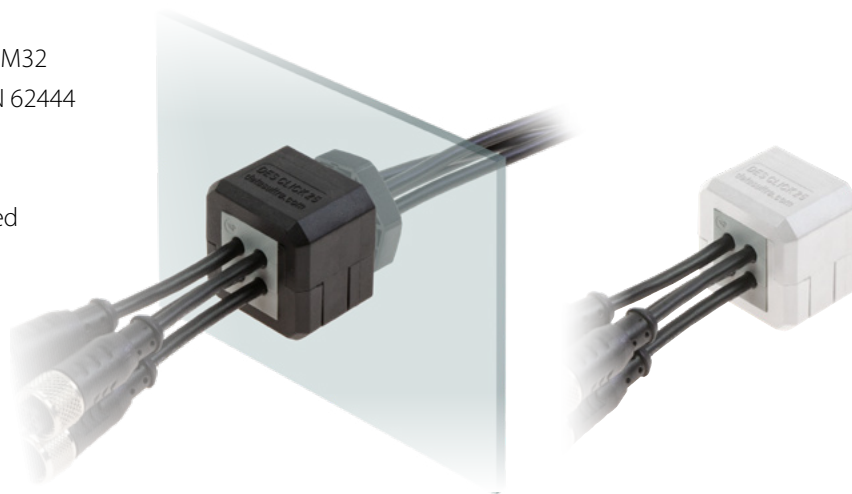

Model	Code	Max. grommet sizes			Cut-out Ø [mm]	Pcs /pack
		● ●	● ● ● ●	● ● ● ● ● ●		
DESCCLICK 20B	1731051020	SPP 12	SPP 2x5	SPP 4x2	20,5	10
DESCCLICK 25B	1731051025	SPP 16	SPP 2x6	SPP 4x4	25,5	
DESCCLICK 32B	1731051032	SPP 16	SPP 2x7	SPP 4x6	32,5	
DESCCLICK 20G	1731051320	SPP 12	SPP 2x5	SPP 4x2	20,5	
DESCCLICK 25G	1731051325	SPP 16	SPP 2x6	SPP 4x4	25,5	
DESCCLICK 32G	1731051332	SPP 16	SPP 2x7	SPP 4x6	32,5	

DESCCLICK is a metric, divisible cable gland for cables with and without connectors. DESCCLICK works with single and multiple cable grommets ranging from 2 to 16 mm diameter.

Technical data

Material: PC

Flammability: self-extinguishing acc. to UL94-V0

Temperature: -40°C... +130°C (static)

Features: halogens and silicones free

Related products

SPP grommets (from page 43)

HY360 hydraulic punch driver (page 129)

Divisible locknuts (page 37-38)

1

Dimensions [mm]

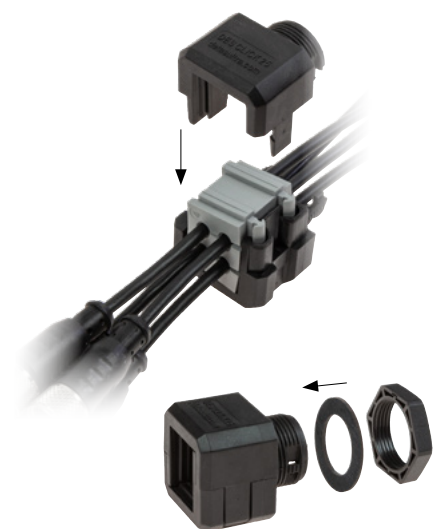
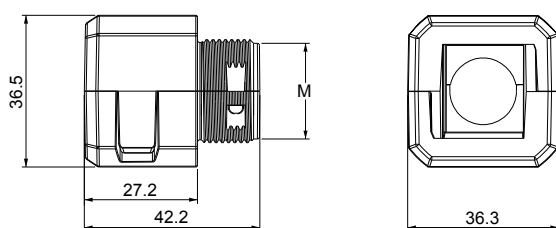

IP54

NEMA 12

UL TYPE 12



UL94-V0



RoHS COMPLIANT

IK10



DESCCLICK 50



Divisible cable glands with locknut

- ▶ Without screws
- ▶ Strain relief according to EN 62444
- ▶ M50 metric size
- ▶ Sturdy construction IK10
- ▶ IP54



DESCCLICK 50 is a divisible cable gland with M50 thread. It includes the M50 nut. DESCCLICK 50 can be used for small, multiple, perforable and big grommets for cables with or without connectors.

Technical data

Material: PC

Flammability: self-extinguishing acc. to UL94-V0

Temperature: -40°C... +130°C (static)

Features: halogens and silicones free

Related products

SPP grommets (page 43)

SPG grommets (page 49)

HY360 hydraulic punch driver (page 129)

Divisible locknuts (page 37-38)

Model	Code	Max. grommet sizes				Cut-out Ø [mm]	Pcs /pack
		SPP 15	SPP 2x6	SPP 4x3	SPG 34		
DESCCLICK 50B	1731051050					50,5	10
DESCCLICK 50G	1731051350					50,5	10

Some possible configurations

Dimensions [mm]

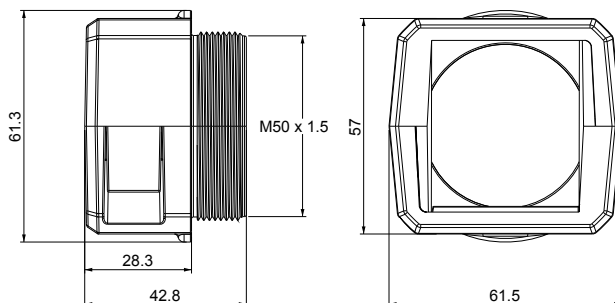

IP54

NEMA
12

UL TYPE
12



UL94-V0



RoHS
COMPLIANT

IK10



Divisible cable glands with locknut

- ▶ Frame screws in AISI304 Stainless Steel with Black Dacromet finishing
- ▶ M25, M32 and M63 metric sizes
- ▶ IP66 and NEMA 4X* certified
- ▶ Strain relief according to EN 62444
- ▶ Sturdy construction IK10
- ▶ Integrated gasket
- ▶ ATEX version on request (see group 7)

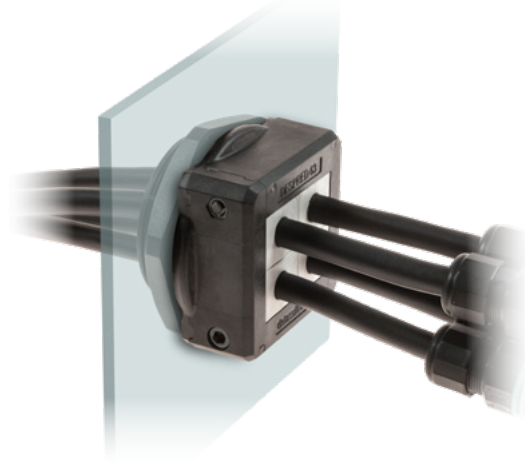

Model	Code	Some possible configurations	Cut-out Ø [mm]	Pcs /pack
DESPRED 25	1731050025		25,5	10
DESPRED 32	1731050032		32,5	
DESPRED 63	1731050063		63,5	

The DESPRED series are divisible cable glands with metric thread.

The 63 model can be used with small, multiple and large grommets for cables up to to 34 mm diameter. With multiple grommets it is possible to accommodate up to 16 cables. Future cable size changes can also be easily accommodated using various grommets.

Technical data

Material: PP+GF

Flammability: self-extinguishing acc. to UL94-V0

Temperature: -40°C... +155°C (static)

Features: halogens and silicones free

Related products

SPP grommets (page 43)

SPG grommets (page 49)

HY360 hydraulic punch driver (page 129)

Divisible locknuts (page 37-38)

1

Dimensions [mm]

DESPRED 25

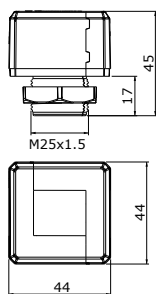

DESPRED 32

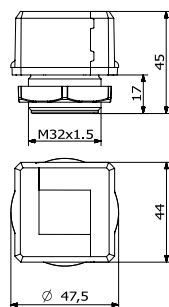

DESPRED 63

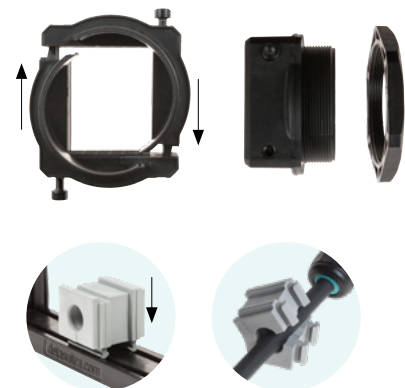
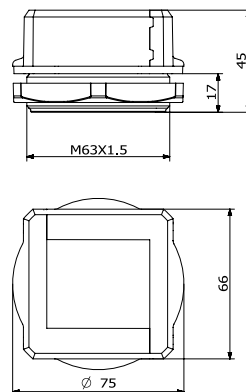

* Indoor only



IP66

NEMA 12, 4X

UL TYPE 12, 4X



ECOLAB



IK10





DESPRED 50-90



Divisible cable gland with locknut - 90° entry

- ▶ Without screws
- ▶ Metric size
- ▶ Strain relief according to EN 62444
- ▶ IP54
- ▶ Sturdy construction IK10



Model	Code	Some possible configurations	Max. cut-out Ø [mm]	Pcs /pack
DESPRED 50-90	1731050250		50,5	10

DESPRED 50-90 is a M50 metric, divisible cable gland with a 90° entry. It works with small, multiple and large grommets for cables ranging from 2 to 17 mm diameter.

The multiple grommets allow to accommodate up to 16 cables. Large grommets are used with corrugated tubes.

Technical data

Material: PA66+GF

Flammability: self-extinguishing acc. to UL94-V0

Temperature: -40°C... +155°C (static)

Features: halogens and silicones free

Related products

SPP grommets (page 43)

SPG grommets (page 49)

HY360 hydraulic punch driver (page 129)

1

Dimensions [mm]

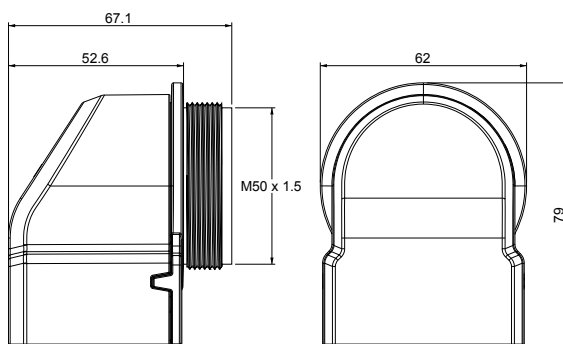

IP54

NEMA
12

UL TYPE
12



ECOLAB

UL94-V0



RoHS
COMPLIANT

IK10



Divisible locknuts M20, M25, M32, M40, M50, M63

NEW

- ▶ Divisible metric thread locknuts
- ▶ UL94-V0
- ▶ Black colour
- ▶ Recommended tightening torque 7 Nm



Model	Code	Thread	Pcs pack
DDMD M20	1731253020	M20	10
DDMD M25	1731253025	M25	
DDMD M32	1731253032	M32	
DDMD M40	1731253040	M40	
DDMD M50	1731253050	M50	
DDMD M63	1731253063	M63	

The DDMD divisible locknuts allow the pass through of connectors which are dimensionally larger than the conventional locknuts. Six sizes are available, all for metric threads.

Technical data

Material: PA66

Flammability: self-extinguishing acc. to UL94-V0

Temperature: -40°C... +120°C (static)

Features: halogens and silicones free

Related products

- OSF
- OSF40
- OSF 90
- DESPRED
- DESPRED ZZ
- DESLICK
- DESLICK 50
- DESLICK Z

Dimensions [mm]

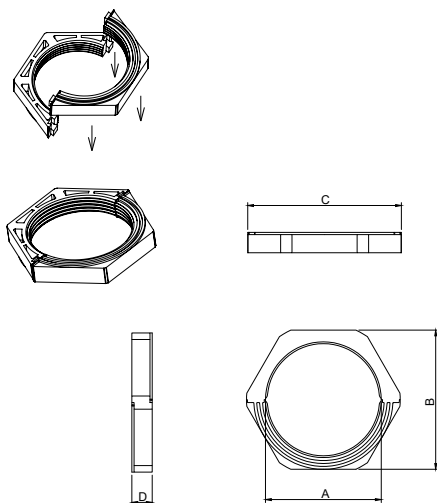



DDM SUB-D9



SUB-D9 locknut

- ▶ Divisible metric thread locknuts, suitable to SUB-D9 connector (DVI, Profibus)
- ▶ UL94-V0
- ▶ Black colour
- ▶ Recommended tightening torque 8 Nm



Model	Code	Thread	Pcs pack
DDM SUB-D9	1731052032	Locknut M32 for SUB-D9	10

This locknut allows the pass through of SUB-D9 connectors (DVI or PROFIBUS), in the case of using a M32 cable gland, simplify machinery wiring.

Available on demand and suitable to: DESCLICK 32, DESPRED 32, DESPRED ZZ 32, OSF 32.

Technical data

Material: Polyamide (PA66)

Flammability: self-extinguishing acc. to UL94-V0

Temperature: -40°C... +120°C (static)

Features: halogens and silicones free

Related products

OSF DESCLICK
OSF 90 DESCLICK Z
DESPRED
DESPRED ZZ

1

Dimensions [mm]

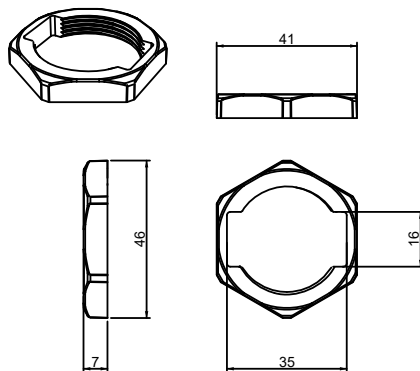

IK10



Grommets single, double, quadruple for OSF Family

- ▶ Openable cable grommets for diameters from 2 to 14 mm
- ▶ "Blind" version available
- ▶ Grey and black versions
- ▶ UL94-V0 for both colors

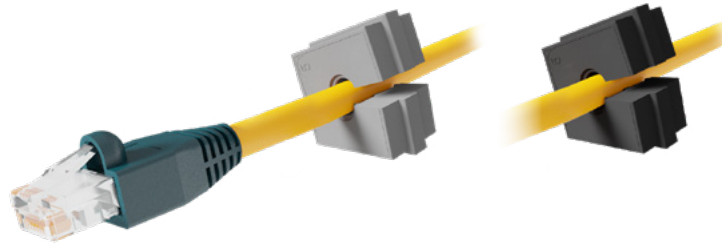

Model	Code	Ø Cable [mm]	Model	Code	Pcs /pack
		■			
SPC 0G	1731052500	"blind"	SPC 0B	1731052600	10
SPC 2G	1731052502	2-3	SPC 2B	1731052602	
SPC 3G	1731052503	3-4	SPC3B	1731052603	
SPC 4G	1731052504	4-5	SPC 4B	1731052604	
SPC 5G	1731052505	5-6	SPC 5B	1731052605	
SPC 6G	1731052506	6-7	SPC 6B	1731052606	
SPC 7G	1731052507	7-8	SPC 7B	1731052607	
SPC 8G	1731052508	8-9	SPC 8B	1731052608	
SPC 9G	1731052509	9-10	SPC 9B	1731052609	
SPC 10G	1731052510	10-11	SPC 10B	1731052610	
SPC 11G	1731052511	11-12	SPC 11B	1731052611	
SPC 12G	1731052512	12-13	SPC 12B	1731052612	
SPC 13G	1731052513	13-14	SPC 13B	1731052613	
SPC 14G	1731052514	14-15	SPC 14B	1731052614	
		■ ■			
SPC 2x2G	1731052522	2	SPC 2x2B	1731052622	10
SPC 2x3G	1731052523	3	SPC 2x3B	1731052623	
SPC 2x4G	1731052524	4	SPC 2x4B	1731052624	
SPC 2x5G	1731052525	5	SPC 2x5B	1731052625	
SPC 2x6G	1731052526	6	SPC 2x6B	1731052626	
SPC 2x7G	1731052527	7	SPC 2x7B	1731052627	
		■ ■ ■			
SPC 4x2G	1731052532	2	SPC 4x2B	1731052632	10
SPC 4x3G	1731052533	3	SPC 4x3B	1731052633	
SPC 4x4G	1731052534	4	SPC 4x4B	1731052634	
SPC 4x4,5G	1731052537	4,5	SPC 4x4,5B	1731052637	
SPC 4x5G	1731052535	5	SPC 4x5B	1731052635	
SPC 4x6G	1731052536	6	SPC 4x6B	1731052636	

The SPC cable grommets are openable grommets which can be used into the OSF or DES "XX" CLICK series for routing preterminated cables with diameters from 2 to 14 mm.

The 2X and 4X allow multiple cables to be routed into the same cable gland.

Technical data

Material: TPE

Flammability: self-extinguishing acc. to UL94-V0 (grey or black)

Temperature: -40°C... +110°C (static)

Features: halogens and silicones free

Related products

- OSF DES 16 CLICK
- OSF 90 DES 10 CLICK
- OSF ZIP DES Q CLICK
- DES 24 CLICK



Dimensions [mm]

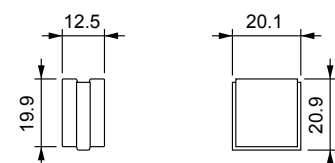

1



SPC K



SPC grommets with extended range for cables without connectors

- ▶ Diameters from 2,5 to 14 mm
- ▶ "Blind" pierceable grommets
- ▶ Grey and black colours available
- ▶ UL94-V0 for both colours
- ▶ IP54

NEW



Model	Code	Ø Cable [mm]	Model	Code	Pcs /pack
SPC K0G	1731052495		SPC K0B	1731052595	10
SPC K1G	1731052550	max. 8	SPC K1B	1731052650	
SPC K2G	1731052555	max. 11	SPC K2B	1731052652	
SPC K3G	1731052560	max. 13	SPC K3B	1731052654	
SPC K4G	1731052565	max. 14	SPC K4B	1731052656	

The SPC K grommets have a dual function: they can be used as "blind" grommets for future application of single cable without connector or they can be used as single grommet for one cable without connector. The size can be chosen between 4 models from 2,5 a 14mm diameter. The "K0" model cannot be perforated. The double membrane ensures the best water and dust protection together with a remarkable strain relief function.

Technical data

Material: TPE

Flammability: self-extinguishing acc. to UL94-V0 (grey or black)

Temperature: -40°C... +110°C (static)

Features: halogens and silicones free

Related products

- DES 24 CLICK OSF
- DES 16 CLICK OSF 90
- DES 10 CLICK OSF ZIP
- DES Q CLICK

1

Dimensions [mm]

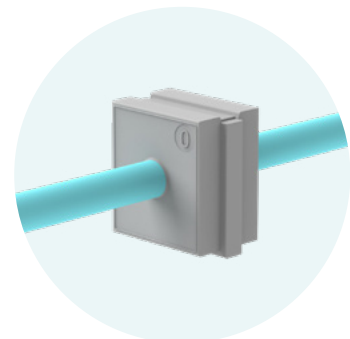
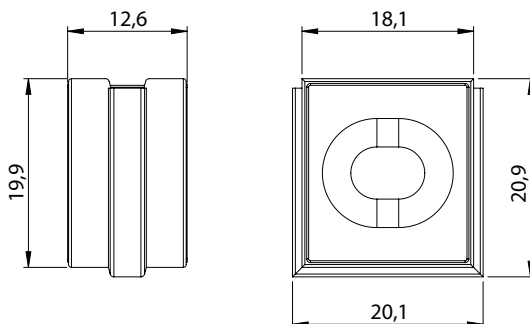

IP54

NEMA 12



ECOLAB





DES grommets - large with extended range

- ▶ Large grommets for cables from 11,5 to 31 mm diameter
- ▶ Usable in CLICK frames
- ▶ "Blind" version available
- ▶ Grey and black colours available
- ▶ UL94-V0 for both colours
- ▶ IP54

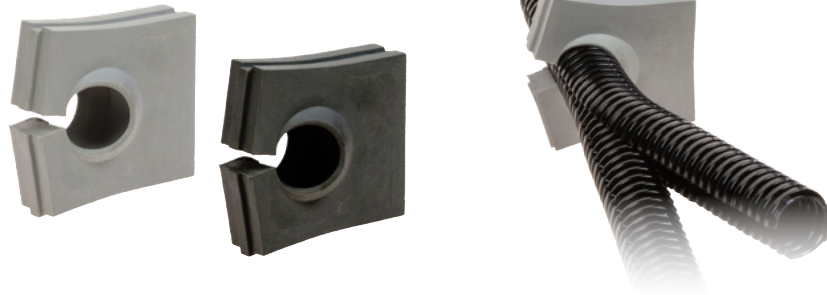

Model	Code	Ø Cable min/max [mm]	Model	Code	Pcs /pack
SPL 0G	1731053000	"blind"	SPL 0B	1731053001	10
SPL 13G	1731053005	11,5-16	SPL 13B	1731053025	
SPL 17G	1731053010	16-20	SPL 17B	1731053030	
SPL 21G	1731053013	20-24	SPL 21B	1731053033	
SPL 25G	1731053015	24-28	SPL 25B	1731053035	
SPL 29G	1731053020	28-31	SPL 29B	1731053040	

The SPL cable grommets are openable grommets which can be used into the DES 24, 16, 10, Q CLICK frames for cables with diameters from 11,5 to 31 mm.

Technical data

Material: TPE

Flammability: self-extinguishing acc. to UL94-V0 (grey or black)

Temperature: -40°C... +110°C (static)

Features: halogens and silicones free

Related products

DES 24 CLICK

DES 16 CLICK

DES 10 CLICK

DES Q CLICK

1

Dimensions [mm]

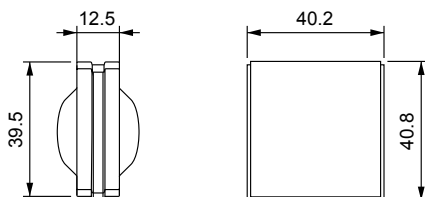

IP54

NEMA 12



ECOLAB





Large multiple grommets for cables without connectors - double membrane

- ▶ Multiple grommets for high number of cables without connectors
- ▶ Grey and black colours available
- ▶ UL94-V0 for both colors
- ▶ Strain relief according to EN 62444



Model	Code	Cable nr.	Ø Cable min/max [mm]	Model	Code	Pcs /pack
SPL M4G	1731053050	4-	11/15	SPL M4B	1731053060	10
SPL M8G	1731053055	8-	6/10	SPL M8B	1731053065	
SPL M13G	1731053058	13-	4,5/6,5	SPL M13B	1731053068	

The SPL M rubber grommets allow many non-terminated cables to be routed through the DES "xx" Click family frames, taking up little space compared to the conventional cable glands.

After having slightly perforated the front membrane, the cable of the required dimensions is pushed through the wall where the second membrane allows a perfect mechanical and fluidic seal.

Technical data

Material: PA66

Flammability: self-extinguishing acc. to UL94-V0

Temperature: -40°C... +120°C (static)

Features: halogens and silicones free

Related products

- DES 24 CLICK
- DES 16 CLICK
- DES 10 CLICK
- DES Q CLICK

Dimensions [mm]

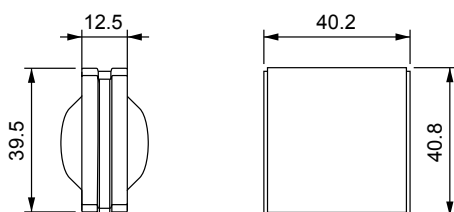

IP54

NEMA 12



ECOLAB





SPP grommets - small: single, double and quadruple

- ▶ Grommets for cables from 2 to 17 mm diameter
- ▶ "Blind" version available
- ▶ Grey and black colours available
- ▶ UL94-V0 for both colours
- ▶ ATEX version on request (see group 7)



Model	Code	Ø Cable [mm]	Model	Code	Pcs /pack
		■			
SPP 0G	1731020100	"blind"	SPP 0B	1731020200	10
SPP 2G	1731020102	2-3	SPP 2B	1731020202	
SPP 3G	1731020103	3-4	SPP 3B	1731020203	
SPP 4G	1731020104	4-5	SPP 4B	1731020204	
SPP 5G	1731020105	5-6	SPP 5B	1731020205	
SPP 6G	1731020106	6-7	SPP 6B	1731020206	
SPP 7G	1731020107	7-8	SPP 7B	1731020207	
SPP 8G	1731020108	8-9	SPP 8B	1731020208	
SPP 9G	1731020109	9-10	SPP 9B	1731020209	
SPP 10G	1731020110	10-11	SPP 10B	1731020210	
SPP 11G	1731020111	11-12	SPP 11B	1731020211	
SPP 12G	1731020112	12-13	SPP 12B	1731020212	
SPP 13G	1731020113	13-14	SPP 13B	1731020213	
SPP 14G	1731020114	14-15	SPP 14B	1731020214	
SPP 15G	1731020115	15-16	SPP 15B	1731020215	
SPP 16G	1731020116	16-17	SPP 16B	1731020216	
		■ ■			
SPP 2x2G	1731020304	2 x 2	SPP 2x2B	1731020404	10
SPP 2x3G	1731020306	2 x 3	SPP 2x3B	1731020406	
SPP 2x4G	1731020308	2 x 4	SPP 2x4B	1731020408	
SPP 2x5G	1731020310	2 x 5	SPP 2x5B	1731020410	
SPP 2x6G	1731020312	2 x 6	SPP 2x6B	1731020412	
SPP 2x7G	1731020314	2 x 7	SPP 2x7B	1731020414	
SPP 2x8G	1731020316	2 x 8	SPP 2x8B	1731020416	
		■ ■ ■			
SPP 4x2G	1731020318	4 x 2	SPP 4x2B	1731020418	10
SPP 4x3G	1731020320	4 x 3	SPP 4x3B	1731020420	
SPP 4x4G	1731020322	4 x 4	SPP 4x4B	1731020422	
SPP 4x5G	1731020324	4 x 5	SPP 4x5B	1731020424	
SPP 4x6G	1731020326	4 x 6	SPP 4x6B	1731020426	
		■			
SPP ASI G	1731021130	1 x ASI	-	-	10
SPP ASI2 G	1731021140	2 x ASI	-	-	

The SPP grommets enable several cables from 2 to 17 mm diameter to be installed in the DES splittable frame.

The 2X and 4X* versions allow multiple cables in the same grommet.

Technical data

Material: TPE

Flammability: self-extinguishing acc. to UL94-V0 (grey or black)

Temperature: -40°C... +110°C (static)

Features: halogens and silicones free

Related products

DES 24	DESPRED	DES 16M
DES 16	DESCCLICK	DES 16MX
DES 10	DES 24M	
DES Q	DES 24MX	

Dimensions [mm]

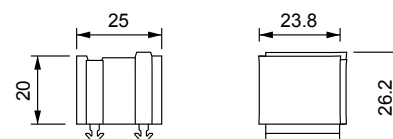

* Indoor only



SPP grommets with extended range

NEW

- ▶ For cables with or without connectors
- ▶ Multi-Range grommets for cables from 3 to 15 mm diameter
- ▶ Only 4 models covering the entire range
- ▶ Grey and black colours available
- ▶ UL94-V0 for both colours
- ▶ IP66

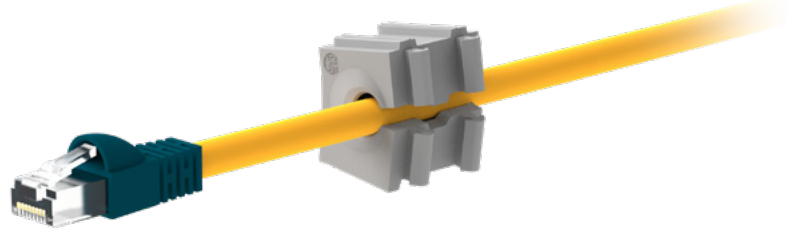

Double parallel membrane

Model	Code	Ø Cable min/max [mm]	Model	Code	Pcs /pack
SPP R1G	1731021200	3...6	SPP R1B	1731021210	10
SPP R2G	1731021202	6...9	SPP R2B	1731021212	
SPP R3G	1731021204	9...12	SPP R3B	1731021214	
SPP R4G	1731021206	12...15	SPP R4B	1731021216	

The openable extended range grommets of the SPP R family allow cables with or without connectors to be routed through all DES frames. Four models are available covering diameters from 3 to 15 mm (R1...R4).

The SPP R grommets improves cable grommets management at the warehouse or for any kind of after sales service.

Technical data

Material: TPE

Flammability: self-extinguishing acc. to UL94-V0 (grey or black)

Temperature: -40°C... +110°C (static)

Features: halogens and silicones free

Related products

DES 24	DESPRED	DES 24MX15
DES 16	DESCLICK	DES 16M
DES 10	DES 24M	DES 16MX
DES Q	DES 24MX	

1

Dimensions [mm]

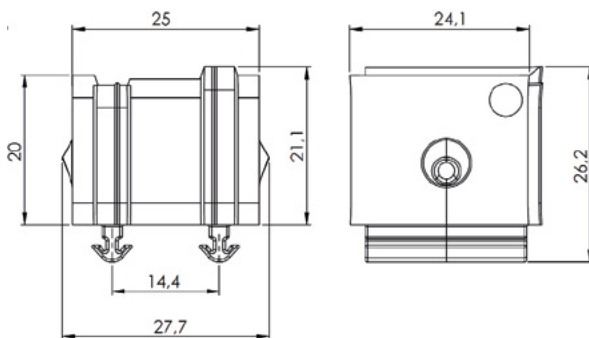

* Indoor only



SPP grommets with extended range - for cables without connectors

- ▶ Diameters from 2,5 to 16,5 mm
- ▶ "Blind" pierceable grommets
- ▶ Grey and black colours available
- ▶ UL94-V0 for both colours
- ▶ IP66
- ▶ ATEX version on request (see group 7)



Model	Code	Ø Cable min/max [mm]	Model	Code	Pcs /pack
SPP K0G	1731021100	"blind"	SPP K0B	1731023100	10
SPP K1G	1731021110	2,5/7	SPP K1B	1731023110	
SPP K2G	1731021115	4,5/10	SPP K2B	1731023115	
SPP K3G	1731021120	7,5/12,5	SPP K3B	1731023120	
SPP K4G	1731021125	9/14	SPP K4B	1731023125	
SPP K5G	1731021127	12/16,5	SPP K5B	1731023127	

The SPP K grommets have a dual function: they can be used as "blind" grommets for future application of single cable without connector or they can be used as single grommet for one cable without connector.

The size can be chosen between 4 models from 2,5 a 16,5 mm diameter.

The double membrane ensures the best water and dust protection together with a great strain relief function.

Technical data

Material: TPE

Flammability: self-extinguishing acc. to UL94-V0 (grey or black)

Temperature: -40°C... +110°C (static)

Features: halogens and silicones free

Related products

DES 24	DESPRED	DES 16M
DES 16	DESLICK	DES 16MX
DES 10	DES 24M	
DES Q	DES 24MX	

NEW

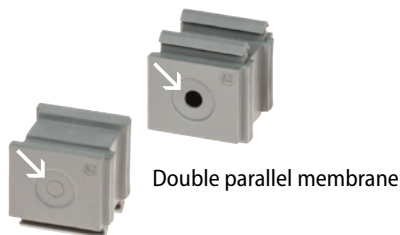

Dimensions[mm]

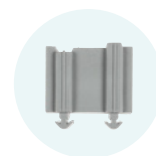
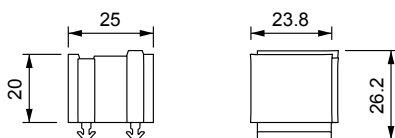

* Indoor only



IP66

NEMA 12, 4X

UL TYPE 12, 4X



ECOLAB



ROHS COMPLIANT





SPP P



SPP multi-range grommets with pyramidal shape for cables without connectors

- ▶ Universal solution for cables without connectors from 2 to 14mm diameter
- ▶ Only one model covering cable diameter from 2 to 14mm
- ▶ Can be used on all DES Frames and Divisible cable glands
- ▶ IP66
- ▶ UL94-V0 for both grey and black colors

NEW

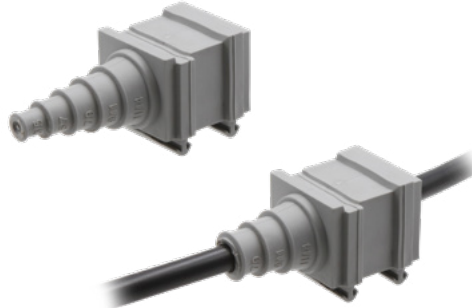

Model	Code	Thread	Pcs /pack
 SPP PG	1731020650	2-14	10
 SPP PB	1731020652		10

The SPP P grommets are suitable for cables without connectors. They are used cutting the cone at the point corresponding to the diameter of the cable. The cable is then routed into the grommet where the internal shape is increasing the strain relief.

Is it also possible to secure the cable with a cable tie.

Technical data

Material: TPE

Flammability: self-extinguishing acc. to UL94-V0

Temperature: -40°C... +110°C (static)

Features: halogens and silicones free

Related products

DES 24	DESPRED	DES 24MX
DES 16	DESCLICK	DES 16M
DES 10	DES 24M	DES 16MX
DES Q	DES 24MX15	

1

Dimensions [mm]

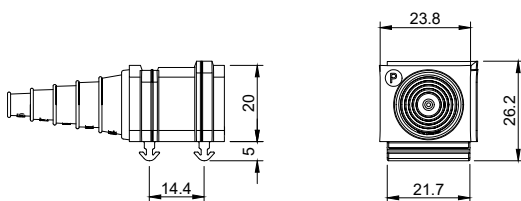

* Indoor only



IP66

NEMA 12, 4X

UL TYPE 12, 4X



ECOLAB





DES grommets with extended range - for cables without connectors

- ▶ Cable diameter max. 7 mm
- ▶ "Blind" pierceable grommets
- ▶ Grey and black colours available
- ▶ UL94-V0 for both colours
- ▶ ATEX version on request (see group 7)

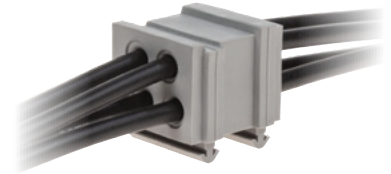

Model	Code	Cable nr.	Ø Cable [mm]	Model	Code	Pcs /pack
SPP M4G	1731020504	4-	max. 6	SPP M4B	1731020604	10
SPP M4bG	1731020505	2- 2-	max. 3 max. 7	SPP M4bB	1731020605	

The SPP M grommets have a dual function: they can be used as "blind" grommets for future application of multiple cables without connector or they can be used in the DES splittable frame as multi grommets for non terminated cables.

The double membrane ensures the highest water and dust protection.

Technical data

Material: TPE

Flammability: self-extinguishing acc. to UL94-V0 (grey or black)

Temperature: -40°C... +110°C (static)

Features: halogens and silicones free

Related products

DES 24	DESPRED	DES 24MX
DES 16	DESCLICK	DES 16M
DES 10	DES 24M	DES 16MX
DES Q	DES 24MX15	

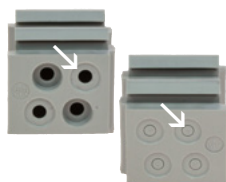

Double parallel membrane

Dimensions [mm]

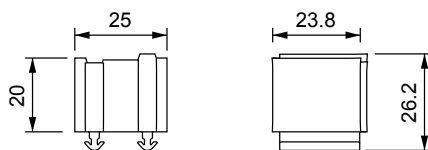

* Indoor only

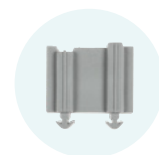

IP66

NEMA 12, 4X

UL TYPE 12, 4X



ECOLAB



ROHS COMPLIANT





SPP F



Small grommets with threaded inserts

- ▶ Cable grommet with female thread for pneumatic connection sleeve and other connectors
- ▶ Continuous thread for 1/4" and 1/8" models, only front on M8 / M12

NEW



M8 x 0,5



M12 x 1



SPP F1/8G



M16 x 1,5

SPP F1/4G

Thanks to the integrated metric thread, the SPP F series can be used as terminals for sensors, pneumatics, etc.

Technical data

Material: TPE, brass insert

Flammability: self-extinguishing acc. to UL94-V0

Temperature: -40°C... +110°C (static)

Features: halogens and silicones free

Related products

DES 24	DESPRED	DES 24MX
DES 16	DESCCLICK	DES 16M
DES 10	DES 24M	DES 16MX
DES Q	DES 24MX15	

Model	Code	Thread	Pcs /pack
SPP F8G	1731020708	M8 x 0,5	10
SPP F12G	1731020712	M12 x 1	
SPP F16G	1731020716	M16 x 1,5	
SPP F1/4G	1731020725	1/4"	
SPP F1/8G	1731020728	1/8"	

NEW

SPP VENT

Small grommet with pressure compensation valve

- ▶ Quick assembly
- ▶ M12 thread

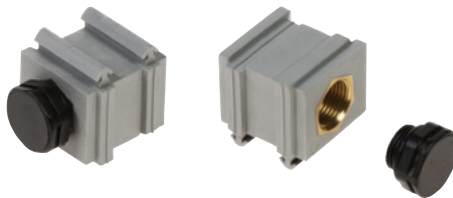

Model	Code	Thread	Pcs /pack
SPP VENT G	1731020720	M12	10

SPP VENT is a pressure-compensating rubber seal, recommended for environments requiring uniform pressure.

The depressurising grommet is inserted into DES partitioned frames and thanks to its valve, compensates for the pressure of the environment and thus avoids temperature differences and consequent condensation.

The ventilation element has an M12x1.5 thread and can be removed to use threaded connectors and sensors.

Technical data

Material: TPE, valve in PP, brass insert

Flammability: self-extinguishing acc. to UL94-V0

Temperature: -40°C... +110°C (static)

Features: halogens and silicones free

Related products

DES 24	DES Q	DESPRED
DES 16	DES L	DESCCLICK
DES 10		

up to IP66

up to NEMA 12, 4X

ECOLAB

UL94-V0

UV ISO 4892-2A

RoHS COMPLIANT



DES grommets - large

- ▶ Grommets for cables with and without connectors or for corrugated pipes from 17 to 35 mm diameter
- ▶ 2 "blind" versions available
- ▶ UL94-V0 for both grey and black
- ▶ ATEX version on request (see group 7)

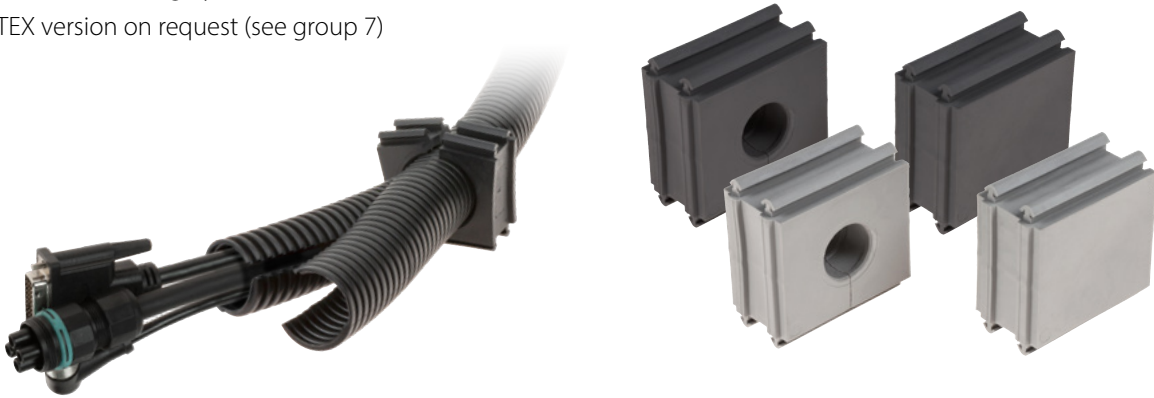

Model	Code	Ø Cable [mm]	Model	Code	Pcs /pack
SPG 0G	1731022000	"blind"	SPG 0B	1731022020	
SPG 17G	1731022117	17-18	SPG 17B	1731022217	
SPG 18G	1731022118	18-19	SPG 18B	1731022218	
SPG 19G	1731022119	19-20	SPG 19B	1731022219	
SPG 20G	1731022120	20-21	SPG 20B	1731022220	
SPG 21G	1731022121	21-22	SPG 21B	1731022221	
SPG 22G	1731022122	22-23	SPG 22B	1731022222	
SPG 23G	1731022123	23-24	SPG 23B	1731022223	
SPG 24G	1731022124	24-25	SPG 24B	1731022224	
SPG 25G	1731022125	25-26	SPG 25B	1731022225	10
SPG 26G	1731022126	26-27	SPG 26B	1731022226	
SPG 27G	1731022127	27-28	SPG 27B	1731022227	
SPG 28G	1731022128	28-29	SPG 28B	1731022228	
SPG 29G	1731022129	29-30	SPG 29B	1731022229	
SPG 30G	1731022130	30-31	SPG 30B	1731022230	
SPG 31G	1731022131	31-32	SPG 31B	1731022231	
SPG 32G	1731022132	32-33	SPG32B	1731022232	
SPG 33G	1731022133	33-34	SPG33B	1731022233	
SPG 34G	1731022134	34-35	SPG34B	1731022234	

The SPG grommets are designed for cables with or without connectors or for corrugated pipes with diameter from 17 to 35 mm.

Technical data

Material: TPE

Flammability: self-extinguishing acc. to UL94-V0 (grey or black)

Temperature: -40°C... +110°C (static)

Features: halogens and silicones free

Related products

DES 24	DESPRED	DES 16M
DES 16	DESCLICK	DES 16MX
DES 10	DES 24M	
DES Q	DES 24MX	

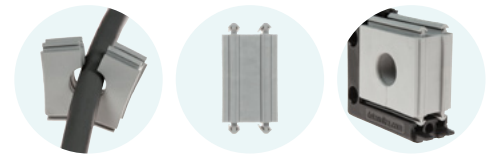

Dimensions [mm]

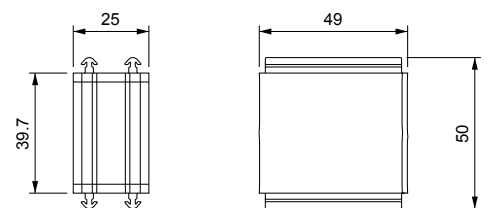

* Indoor only

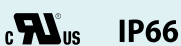

NEMA 12, 4X

UL TYPE 12, 4X



ECOLAB



RoHS COMPLIANT





DES grommets - large - for cables without connectors - double membrane

- ▶ K1, K2 e K3 for cables without connectors with diameters from 16 to 30 mm
- ▶ K0 blind grommet
- ▶ IP66 for SPG K1, K2 and K3
- ▶ ATEX version on request (see group 7)



Model	Code	Ø Cable [mm]	Model	Code	Pcs /pack
SPG K0G	1731022300	max. 32	SPG K0B	1731022400	10
SPG K1G	1731022310	16 - 22	SPG K1B	1731022410	
SPG K2G	1731022320	23 - 26	SPG K2B	1731022420	
SPG K3G	1731022330	26 - 30	SPG K3B	1731022430	

The SPG K are blind grommets which can be also used for cables without connectors with diameter from 16 to 30mm.

The SPG K0 can be perforated but the IP protection is not guaranteed.

Thanks to the double membrane in the SPG K1-K2-K3 grommets an optimal dust and water protection are achieved.

Technical data

Material: TPE

Flammability: self-extinguishing acc. to UL94-V0 (grey or black)

Temperature: -40°C... +110°C (static)

Features: halogens and silicones free

Related products

DES 24	DESPRED	DES 16M
DES 16	DESCLICK	DES 16MX
DES 10	DES 24M	
DES Q	DES 24MX	

NEW

1

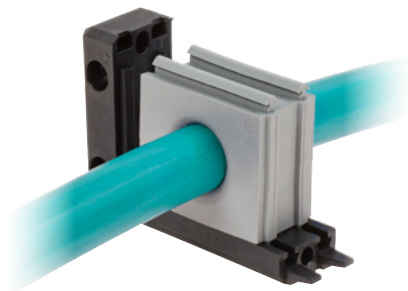

Dimensions [mm]

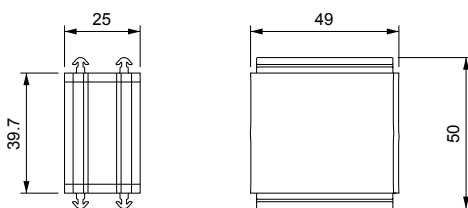

* Indoor only



IP66

NEMA 12, 4X



ECOLAB







SPP multi-range grommets with pyramidal shape for cables without connectors

- ▶ Universal solution for cables without connectors from 17 to 33 mm diameter
- ▶ Can be used on all DES Frames and divisible cable glands
- ▶ IP66
- ▶ UL94-V0 for both grey and black colors

NEW



Model	Code	Thread	Pcs /pack
 SPG PG	1731020745	17-33	10
 SPG PB	1731020748		10

The SPG P grommets are suitable for cables without connectors. They are used cutting the cone at the point corresponding to the diameter of the cable. The cable is then routed into the grommet where the internal shape is increasing the strain relief.

Is it also possible to secure the cable with a cable tie.

Technical data

Material: TPE, brass insert

Flammability: self-extinguishing acc. to UL94-V0

Temperature: -40°C... +110°C (static)

Features: halogens and silicones free

Related products

- DES FRAMES
- DESPRED
- DESLICK 50

1

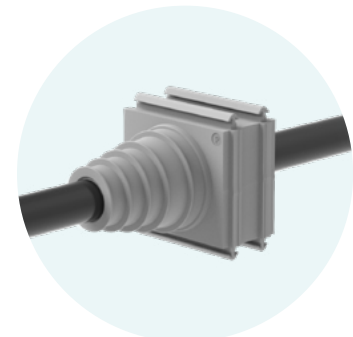
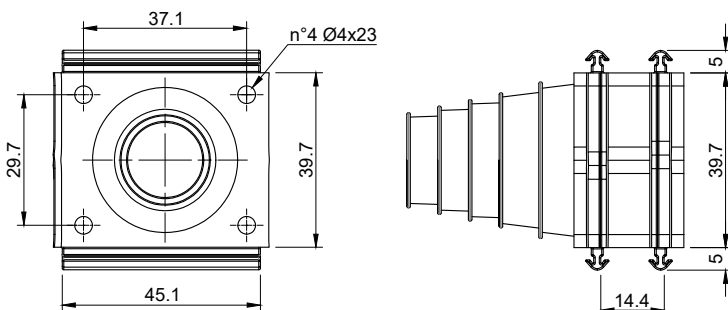

* Indoor only



IP66

NEMA 12, 4X



ECOLAB





DES grommets - large - for cables without connectors - double membrane

- ▶ Multiple grommets for high number of cables without connectors
- ▶ Grey and black colours available
- ▶ UL94-V0 for both colours
- ▶ Strain relief according to EN 62444
- ▶ ATEX version on request (see group 7)

Double parallel membrane

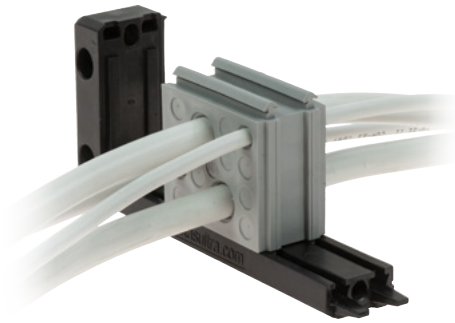
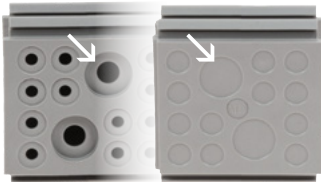

Model	Code	Cable nr. - Ø Cable [mm]	Pcs /pack
SPG M7G	1731022307	4- max. 13,5 2- max. 5 1- max. 9,5	10
SPG M7B	1731022407		
SPG M9G	1731022309	9- max. 8,8	
SPG M9B	1731022409		
SPG M14G	1731022314	12- max. 6,5 2- max. 12	
SPG M14B	1731022414		
SPG M15G	1731022315	15- max. 7	
SPG M15B	1731022415		

The SPG M grommets enable high number of cables without connectors to be routed into the DES splittable frames.

The cable is pushed through the front membrane, whilst the second membrane increases the strain relief and liquid resistance.

Technical data

Material: TPE

Flammability: self-extinguishing acc. to UL94-V0 (grey or black)

Temperature: -40°C... +110°C (static)

Features: halogens and silicones free

Related products

DES 24	DESPRED	DES 16M
DES 16	DESCCLICK	DES 16MX
DES 10	DES 24M	
DES Q	DES 24MX	

Dimensions [mm]

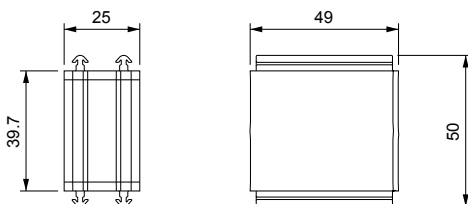

* Indoor only

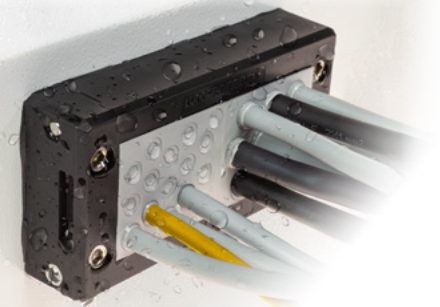

IP66

NEMA 12, 4X

UL TYPE 12, 4X



ECOLAB



RoHS COMPLIANT





Large grommets for drives and service connectors

- ▶ Large grommets for panel connectors with diameters 20 and 22 mm, M12, M25, M23 flanges, square openable flanges, feedthrough, quick inserts for pneumatic, etc.
- ▶ Useful for quick connections without opening the electrical panel
- ▶ Customized solutions welcome



SPG WFP23



SPG WFQ20



SPG WFQ27



SPG WF12



SPG WF25



SPG W22

Model	Code	Application	Pcs /pack
SPG WFP23	1731020830	For M23 flanges	1
SPG WFQ20	1731020815	For squared openable flange □ 38 mm , hole Ø 20 mm (for M15 connectors)	
SPG WFQ27	1731020820	For squared openable flange □ 38 mm with hole Ø 27 mm (for M23 connectors)	
SPG WF12	1731020840	For M12 metric threads	
SPG WF25	1731020850	For M25 metric threads	
SPG W22	1731020810	For Ø 22 mm Panel connectors	

The SPG W grommets allow the integration of panel connectors/sockets (Ø 20 and 22 mm, M12, M25, M23 flanges, openable square flanges, feedthrough, quick inserts for pneumatics, etc.) directly on the DES frames.

The advantage is the modularity of the system that allows **quick connection** and **release** of cables (data, power, pneumatics, etc.) without opening the machine panel.

This plug-in system facilitates the design of increasingly modular machines.

Technical data

Material: TPE, insert PP+GF

Flammability: self-extinguishing acc. to UL94-V0

Temperature: -40°C... +110°C (static)

Features: halogens and silicones free

Related products

DES 24	DESPRED	DES 24MX
DES 16	DESCCLICK	DES 16M
DES 10	DES 24M	DES 16MX
DES Q	DES 24MX15	

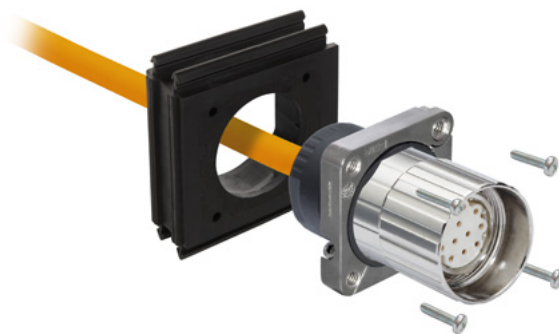

Compatible with a wide variety of panel sockets eg. sockets Ø 20/22 mm, M12, M25, M23 flanges, openable square flanges for M15 and M23 connectors, bulkheads and quick inserts for pneumatics, etc...

some possible configurations



Dimensions [mm]

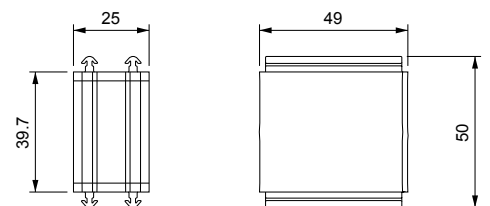

up to IP66

up to NEMA 12, 4X

ECOLAB

UL94-V0

UV ISO 4892-2A

RoHS COMPLIANT



SPG W22



Large grommets for drives and service connectors

- ▶ Large grommets with embedded panel connectors with diameter 22 mm
- ▶ Aluminum or plastic connectors 180° Female/Female or Female/Male
- ▶ Useful for quick connections without opening the electrical panel
- ▶ Metal or plastic panel sockets
- ▶ Degree of protection IP65

NEW



SPG W22 USB 3.0



SPG W22 USB-B



SPG W22 USB-C



SPG W22 USB-Mini



SPG W22 USB-Micro



SPG W22 2xUSB 2.0



SPG W22 RJ45 Cat.6



SPG W22 HDMI



The SPG W22 grommets allow the integration of panel sockets (USB, RJ45 etc...) directly on the DES frame.

The advantage is the modularity of a system that allows the quick coupling and release of data cables without the need to open the machine panel, as well as the guarantee of maintaining a high degree of protection.

This plug-in system facilitates the design of increasingly modular machines.

Technical data

Material: TPE, insert PP+GF, sockets PA66 or aluminum

Flammability: self-extinguishing acc. to UL94-V0

Temperature: -40°C... +110°C (static)

Features: halogens and silicones free

Related products

DES 24	DESPRED	DES 24MX
DES 16	DESCCLICK	DES 16M
DES 10	DES 24M	DES 16MX
DES Q	DES 24MX15	

Dimensions [mm]

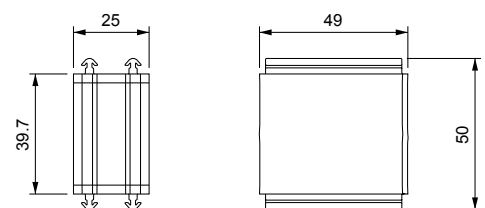

Model	Code	Application	Pcs /pack
SPG W22 USB 3.0	1731020905	With USB 3.0 (f/f) and IP65 cap	1
SPG W22 USB-B	1731020910	With USB-B (f/f) and IP65 cap	
SPG W22 USB-C	1731020915	With USB-C (f/f) and IP65 cap	
SPG W22 USB-Mini	1731020920	With USB-Mini (f/m) and IP65 cap	
SPG W22 USB-Micro	1731020925	With USB-Micro (f/m) and IP65 cap	
SPG W22 RJ45 Cat.6	1731020930	With RJ45 Cat.6 (f/f) and IP65 cap	
SPG W22 HDMI	1731020935	With HDMI (f/f) and IP65 cap	
SPG W22 2xUSB 2.0	1731020940	With 2 USB 2.0 (f/f) and IP65 cap	

up to IP65

up to NEMA 12, 4X

ECOLAB

UL94-V0

UV ISO 4892-2A

RoHS COMPLIANT



Large grommets with connectors for service sockets

NEW

- ▶ SPG grommets with panel sockets D. 20 and 16 mm, USB, RJ45, HDMI e USB-C
- ▶ Female/Female 180°
- ▶ Useful for quick connections without opening the electrical panel
- ▶ Plastic socket with screw cap
- ▶ IP66



SPG WP20 USB 3.0



SPG WP16 USB-C



SPG WP20 RJ45 Cat.6



SPG WP20 HDMI

Model	Code	Application	Pcs /pack
SPG WP20 USB 3.0	1731020907	With USB 3.0 (f/f) and cap	1
SPG WP16 USB-C	1731020913	With USB-C (f/f) and cap	
SPG WP20 RJ45 Cat.6	1731020933	With RJ45 Cat.6 (f/f) and cap	
SPG WP20 HDMI	1731020937	With HDMI (f/f) and cap	

SPG WP grommets allow the integration of USB, RJ45 and HDMI panel sockets directly on the DES frames.

The advantage is the modularity of a system that allows the quick coupling and release of data cables without the need to open the machine panel, as well as the guarantee of maintaining a high degree of protection.

This plug-in system facilitates the design of increasingly modular machines.

Technical data

Material: TPE, insert PP+GF, sockets PA66

Flammability: self-extinguishing acc. to UL94-V0

Temperature: -30°C... +105°C (static)

Features: halogens and silicones free

Related products

DES 24	DESPRED	DES 24MX
DES 16	DESCLICK	DES 16M
DES 10	DES 24M	DES 16MX
DES Q	DES 24MX15	

Dimensions [mm]

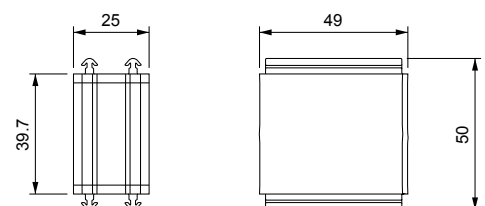

1





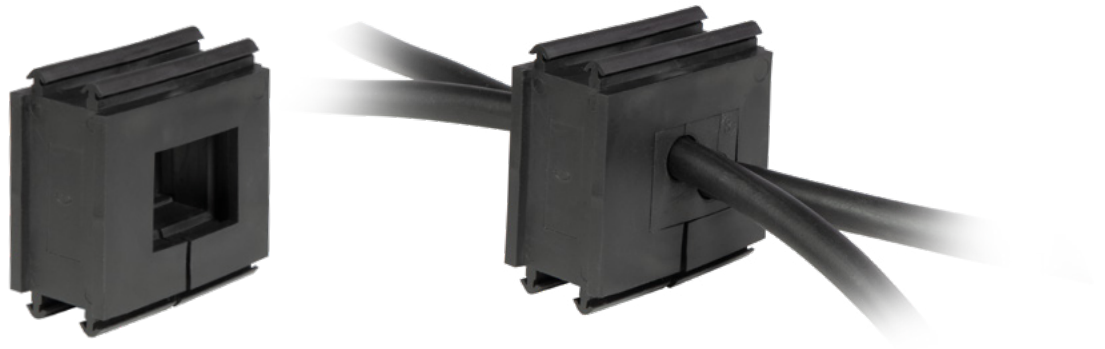

Large/Small adapter grommet

- ▶ Large grommet which can be used as adapter for one small grommet
- ▶ Grey and black colors
- ▶ UL94-V0 for both colors



Model	Code	Pcs pack
 SPG YG	1731022030	10
 SPG YB	1731022035	

The SPG Y is a large grommet which can be used to adapt small grommets, single, multi-hole or special.

They are used in divisible cable glands of the Despred 63 or 50-90 families to improve the cable outlet or in the DES frames to reduce the number of blind grommets

Technical data

Material: TPE

Flammability: self-extinguishing acc. to UL94-V0

Temperature: -40°C... +120°C (static)

Features: halogens and silicones free

Related products

DES 24	DESPRED 63	DES 24MX
DES 16	DESPRED 50-90	DES 16M
DES 10	DECLICK	DES 16MX
DES Q	DES 24M	DES 24MX15

Dimensions [mm]

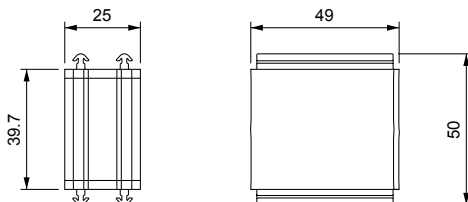

IP54

NEMA 12

ECOLAB

UL94-V0

UV ISO 4892-2A

RoHS COMPLIANT



Grommets for DES 380 series

- ▶ Grommets for big diameter cables and corrugated pipes
- ▶ Cable diameters from 36 to 65 mm
- ▶ UL94-V0
- ▶ IP54

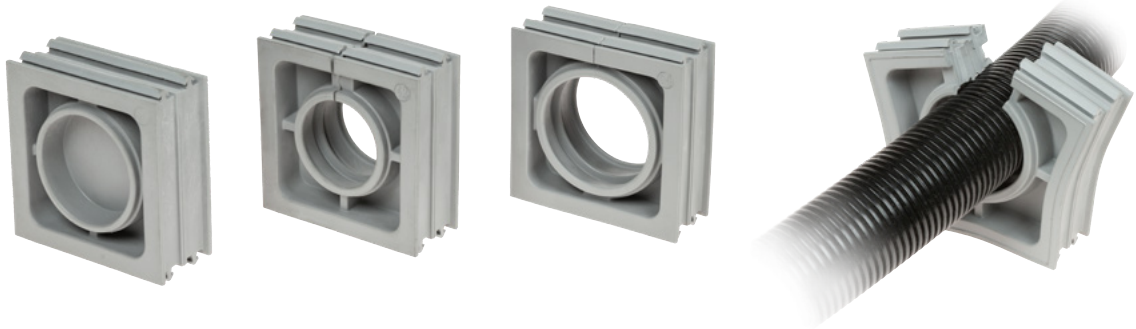

Model	Code	Ø Cable [mm]	Pcs /pack
SPH 0G	1731010278	0	1
SPH 38G	1731010281	36-39	
SPH 42G	1731010282	41-44	
SPH 46G	1731010283	43-48	
SPH 50G	1731010284	47-51	
SPH 54G	1731010285	52-56	
SPH 58G	1731010286	56-60	
SPH 62G	1731010287	60-65	

SPG grommets are used in DES380M and 380MX for cables or corrugated pipes from 36 to 65 mm diameter.

Technical data

Material: TPE

Flammability: self-extinguishing acc. to UL94-V0 (grey or black)

Temperature: -40°C... +110°C (static)

Features: halogens and silicones free

Related products

DES 380M

DES 380MX

1

Dimensions [mm]

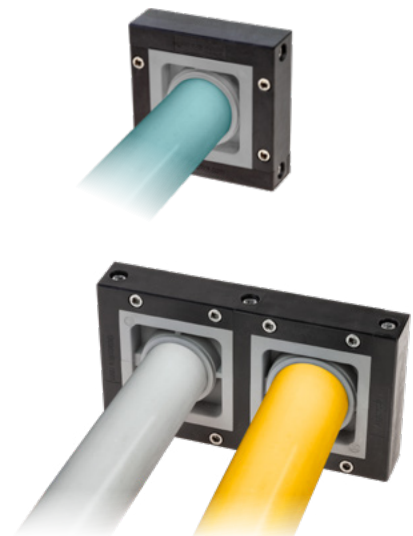
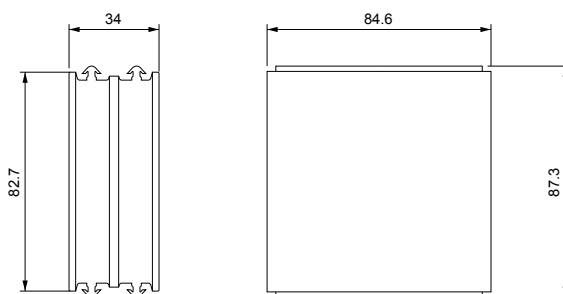

IP54

NEMA 12



ECOLAB





Plugs for SPP and SPC series

► Plastic plugs for grommets, from 2 to 16 mm diameter

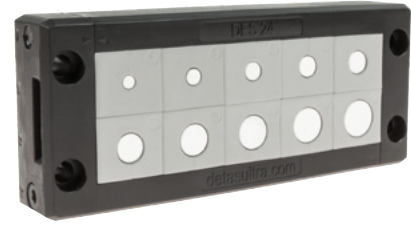
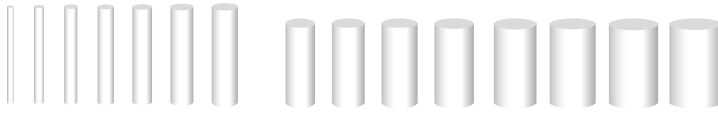

Model	Code	Ø Diameter [mm]	Length [mm]	Pcs /pack
ISP 2	1731040002	2	30	20
ISP 3	1731040003	3		
ISP 4	1731040004	4		
ISP 5	1731040005	5		
ISP 6	1731040006	6		
ISP 7	1731040007	7		
ISP 8	1731040008	8		
ISP 9	1731040009	9		
ISP 10	1731040010	10		
ISP 11	1731040011	11		
ISP 12	1731040012	12		
ISP 13	1731040013	13		
ISP 14	1731040014	14		
ISP 15	1731040015	15		
ISP 16	1731040016	16		

The ISP series grommets are designed to fit into SPP and SPC grommets with diameters from 2 to 16mm.

Technical data

Material: PA66

Flammability: self-extinguishing acc. to UL94-V0

Temperature: -40°C... +155°C (static)

Features: halogens and silicones free

Related products

SPC grommets (page 39)

SPP grommets (from page 43)

up to
IP66

UL94-V0

UV
ISO 4892-2A

RoHS
COMPLIANT

1



DES CAPS

Caps for splittable frames

NEW

- Caps with convex head
- Available with black color
- For DES splittable frames



The DES CAPS keeps the product clean from the front, preventing dirt from settling in the screw seats.

Technical data

Material: HDPE

Related products

DES 10	DES L2	DES Q
DES 16	DES L3	DES 24 M/MX
DES 24	DES L4	DES 16 M/MX
DES FT	DES L5	

Model	Code	Ø Hole [mm]	Dimensions [mm]			Pcs /pack
			A	B	C	
DES CAPS	1732019983	9,5	12	10	6,5	50

Dimensions [mm]

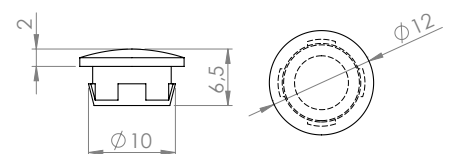

RoHS
COMPLIANT

Utility box SPCL



Box with SPC and SPL grommets

- ▶ SPC single hole
- ▶ SPC multiple
- ▶ SPL multirange
- ▶ Grey or black



Model	Code	Dimensions [mm]	Grommets color	Pcs
Utility box SPCL	1736999862	370 x 300 x 90	■	1
Utility box SPCL	1736999863		■	

GREY GROMMETS BOX CONTENTS				BLACK GROMMETS BOX CONTENTS			
Pcs	Model	Pcs	Model	Pcs	Model	Pcs	Model
SPC GROMMETS							
	●		●●		●		●●
8	0G	4	2x2G	8	0B	4	2x2B
8	2G	8	2x3G	8	2B	8	2x3B
8	3G	8	2x4G	8	3B	8	2x4B
8	4G	8	2x5G	8	4B	8	2x5B
8	5G	8	2x6G	8	5B	8	2x6B
8	6G	8	2x7G	8	6B	8	2x7B
8	7G			8	7B		
8	8G		●●●	8	8B		●●●
8	9G	4	4x2G	8	9B	4	4x2B
8	10G	8	4x3G	8	10B	8	4x3B
8	11G	8	4x4G	8	11B	8	4x4B
8	12G	8	4x5G	8	12B	8	4x5B
8	13G	8	4x6G	8	13B	8	4x6B
8	14G			8	14B		
SPL GROMMETS							
	●		●		●		●
4	0G	4	21-24G	4	0G	4	21-24G
4	13-16G	2	25-28G	4	13-16G	2	25-28G
4	17-20G	2	29-32G	4	17-20G	2	29-32G

The SPCL engineering box contains 212 pcs small SPC and SPL grommets, grey or black.

The full range of grommets is included.

Related products

DES XX CLICK

OSF

OSF 90

OSF ZIP

1



Utility box SPP

Box with SPP samples grommets

- ▶ Single hole
- ▶ Multiple
- ▶ Pierceable
- ▶ M & F
- ▶ Grey or black



Model	Code	Dimensions [mm]	Grommets color	Pcs
Utility box SPP G	1736999860	370 x 300 x 90	■	1
Utility box SPP B	1736999861		■	

GREY GROMMETS BOX CONTENTS				BLACK GROMMETS BOX CONTENTS			
Pcs	Model	Pcs	Model	Pcs	Model	Pcs	Model
	●		●●		●		●●
8	0G	4	2x2G	8	0B	4	2x2B
8	K0G	4	2x3G	8	K0B	4	2x3B
4	2G	4	2x4G	4	2B	4	2x4B
4	3G	4	2x5G	4	3B	4	2x5B
4	4G	4	2x6G	4	4B	4	2x6B
8	5G	4	2x7G	8	5B	4	2x7B
8	6G	4	2x8G	8	6B	4	2x8B
8	7G		●●●	8	7B		●●●
8	8G	4	4x2G	8	8B	4	4x2B
8	9G	4	4x3G	8	9B	4	4x3B
8	10G	4	4x4G	8	10B	4	4x4B
4	11G	4	4x5G	4	11B	4	4x5B
4	12G	4	4x6G	4	12B	4	4x6B
4	13G		■	4	13B		■
4	14G	4	K1G	4	14B	4	K1B
4	15G	4	K2G	4	15B	4	K2B
4	16G	4	K3G	4	16B	4	K3B
		4	K4G			4	K4B
			■				■
		4	M4G			4	M4B

This engineering box contains 168 pcs of small SPP grommets, grey or black.

The full range of grommets is included.

Related products

DES 24 DES 16 DES 10
 DES Q DES L
 DESPRED DESCLICK



Cable frame with brush

- ▶ Brush frame for cables with or without connectors
- ▶ Tidy and cost effective solution
- ▶ Available in three sizes (24, 16 and 10)



Model	Code	Dimensions [mm]		Max. cut-out [mm]	Pcs /pack
		L1	L2		
DES Z 24	1731060024	146	130	112 x 39	10
DES Z 16	1731060016	120	103	86 x 39	
DES Z 10	1731060010	99	83	63 x 39	

The DES Z series is meant for the passage of cables with and without connectors, when there is no need for water tightness and strain relief. Effective protection against dust and debris.

Technical data

Material: PC

Flammability: self-extinguishing acc. to UL94-V0

Temperature: -25°C... +80°C (static)

Features: halogens and silicones free

Related products

DES Cover (page 24)

HY360 hydraulic punch driver (page 129)

PF cable entry system plates (page 130)

Dimensions [mm]

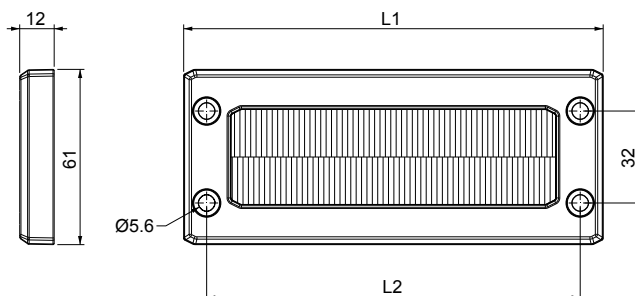



Splittable frame with double brush

- ▶ Brush frame for cables with or without connectors
- ▶ Double brush offering increased dust protection
- ▶ 8 different models (24, 16, 10, Q, L5, L4, L3 and L2)



Model	Code	Dimensions [mm]		Max. cut-out [mm]	Pcs /pack
		L1	L2		
DES ZZ 24	1731060224	146	130	112 x 39	1
DES ZZ 16	1731060216	120	103	86 x 39	
DES ZZ 10	1731060210	99	83	63 x 39	
DES ZZ Q	1731060208	74	58	40 x 39	
DES ZZ L5	1731060205	146	130	108 x 18	
DES ZZ L4	1731060204	120	103	86 x 18	
DES ZZ L3	1731060203	99	83	63 x 18	
DES ZZ L2	1731060202	74	58	40 x 18	

The DES ZZ is a splittable frame with 2 rows of brushes.

The DES ZZ series is meant for the passage of cables with and without connectors, when there is no need for water tightness and strain relief.

Effective protection against dust and debris thanks to the double brush.

Technical data

Material: PP+GF

Flammability: self-extinguishing acc. to UL94-V0

Temperature: -25°C... +80°C (static)

Features: halogens and silicones free

Related products

DES Cover (page 24)

DES Flap (page 25)

HY360 hydraulic punch driver (page 129)

PF cable entry system plates (page 130)

Upon request:	1731991020	Set of 4 mounting screws in AISI304 with Black Dacromet finishing
---------------	------------	---

Dimensions [mm]

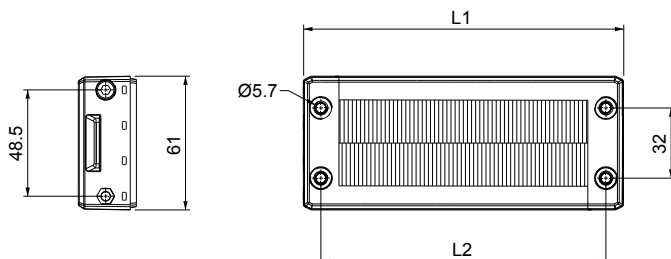



Divisible cable gland with single brush

- ▶ Without screws
- ▶ Metric threads M32 and M50
- ▶ Cost efficient solution
- ▶ Black version

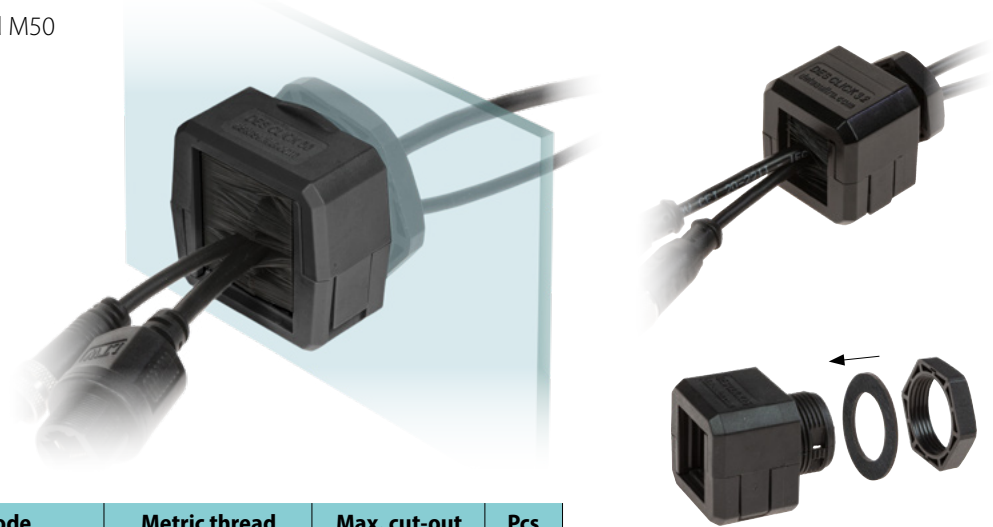

Model	Code	Metric thread	Max. cut-out Ø [mm]	Pcs /pack
DESCCLICK Z 32	1731060332	M32 x 1,5	32,5	10
DESCCLICK Z 50	1731060350	M50 x 1,5	50,5	

DESCCLICK Z is a divisible frame with a single brush providing protection against dust and debris.

Technical data

Material: PC

Flammability: self-extinguishing
acc. to UL94-V0

Temperature: -25°C... +80°C (static)

Features: halogens and silicones free

Related products

HY360 hydraulic punch driver (page 129)

Divisible locknuts (page 38-39)

Dimensions [mm]

DESCCLICK Z 32

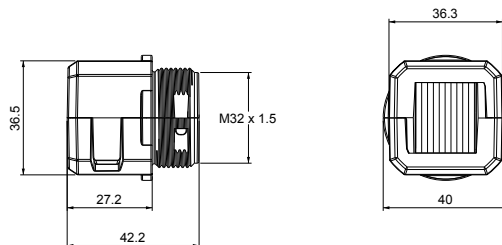

DESCCLICK Z 50

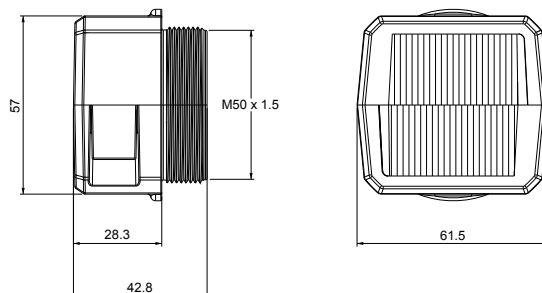



DESPRED ZZ



Splittable frame and locknut with double brush

- ▶ Double brush frame for cables with and without connectors
- ▶ Frame screws in AISI304 Stainless Steel with Black Dacromet finishing
- ▶ Metric threads M32 and M63
- ▶ Double frame offering increased dust protection



Model	Code	Metric thread	Max. cut-out Ø [mm]	Pcs /pack
DESPRED ZZ 32	1731060232	M32 x 1,5	32,5	1
DESPRED ZZ 63	1731060263	M63 x 1,5	63,5	

DESPRED ZZ consists of a square frame with two rows of brushes.

Excellent protection is offered against dust and debris thanks to the double brush.

Technical data

Material: PP+GF

Flammability: self-extinguishing acc. to UL94-V0

Temperature: -25°C... +80°C (static)

Features: halogens and silicones free

Related products

HY360 hydraulic punch driver (page 129)

Divisible locknuts (page 38-39)

1

Dimensions [mm]

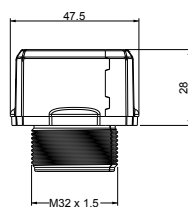

DESPRED ZZ 32

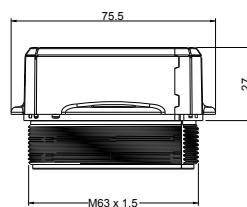

DESPRED ZZ 63

